

P1202

Universal Explosion-proof LED Lighting

NOM This product is in compliance with NOM regulations.

Zone 1

Zone 21

IP68

NEMA 6P



40W



Net Weight: 3.7kg (8.1 lb)

Protection

- Ex d IIB T5 Gb
- Ex tb IIIC T100°C Db

Standards

- JNIOHS-TR-46-1
- JNIOHS-TR-46-2
- JNIOHS-TR-46-9
- IEC 60079-0
- IEC 60079-1
- IEC 60079-31

Light Features

- Compact size, Light weight and Portable
- Applicable to high temperature environment
- Salt spray 1000 hrs passed

Technical Data

Rated Voltage (±10%)	24V / 110V / 220V AC	
Watts (±10%)	40W (Watts of 24V are different, please contact us for details.)	
Amps	40W 24V: 1.67A, 110V: 0.36A, 220V: 0.18A	
Color of LED Light	3000K (Warm White) / 5000K (Cool White)	
Ambient Temperature	-20°C ~ +40°C, T5	
Power Factor	cos ≥ 0.9	
CRI	Cool White ≥ 70 / Warm White ≥ 80	
Lumen (±10%)	COB	40W
	3000K	3800lm
	5000K	4000lm
Beam Angle	X-105° / Y-105°	
Frequency	50 / 60 Hz	
Degree of Protection	IP68 / NEMA 6P	
Material	• Enclosure	Aluminum alloy
	• Glass	Tempered glass
LED Service Life	60,000 hrs	
Entrance Thread	3 × M20	

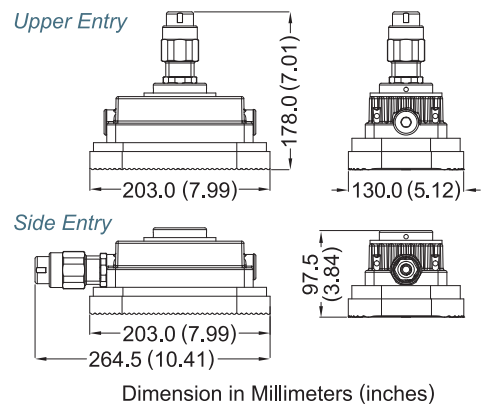

Optical Report

Polar Luminous Intensity Distribution

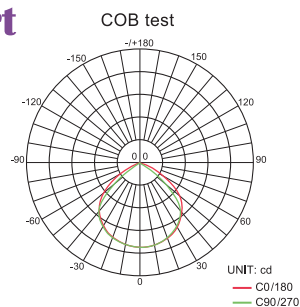

Luminous Intensity Distribution Diagram

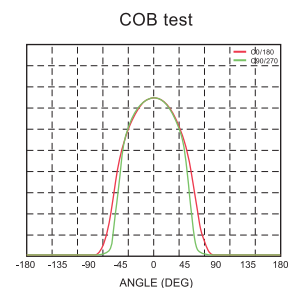

Model Code

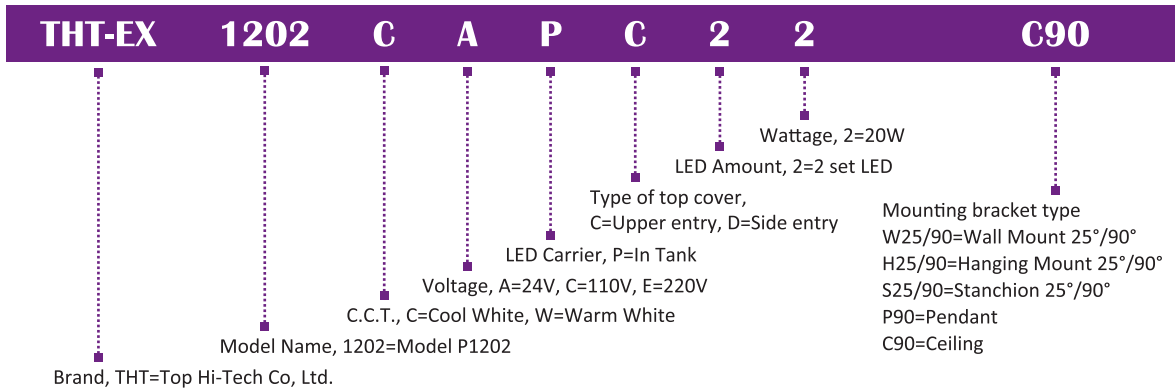

Mounting Option & Dimensions (All in mm)

Wall Mount 25° (W25)	Wall Mount 90° (W90)	Ceiling (C90)	Pendant (P90)
<p>4.6 kg (10.1 lb)</p>	<p>4.6 kg (10.1 lb)</p>	<p>4.1 kg (9.0 lb)</p>	<p>4.3 kg (9.4 lb)</p>
Hanging Mount 25° (H25)	Hanging Mount 90° (H90)	Stanchion 25° (S25)	Stanchion 90° (S90)
<p>4.6 kg (10.1 lb)</p>	<p>4.6 kg (10.1 lb)</p>	<p>4.9 kg (10.8 lb)</p>	<p>5.0 kg (11.0 lb)</p>

Optional Accessory

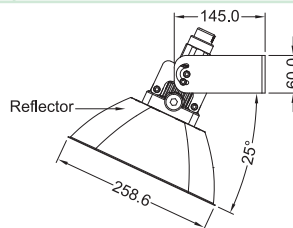
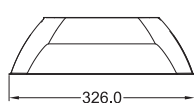
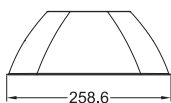

Applicable Area

- Oil Refinery Complex
- Petrochemical Complex
- Painting Facility
- Transporting Nature Gas
- Transporting Liquefied Petroleum Gas
- Offshore Platform (Oil and Natural Gas)