

# NivoGuide 8100, 3100, 8200

Dust ignition protection by enclosure "t"

Two-wire 4 ... 20 mA/HART

Two-wire 4 ... 20 mA/HART with SIL qualification



---

## Safety instructions

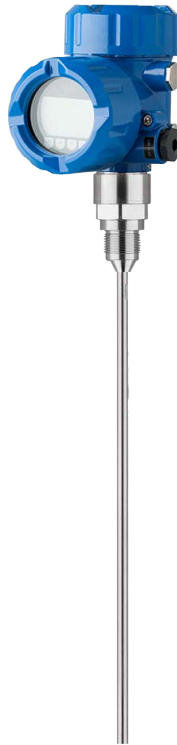

Document ID: 64003



## Contents

|           |  |           |
|-----------|--|-----------|
| <b>1</b>  | <b>Area of applicability.....</b>                              | <b>4</b>  |
| <b>2</b>  | <b>Important specification in the type code.....</b>           | <b>4</b>  |
| <b>3</b>  | <b>Different ignition protection types .....</b>               | <b>7</b>  |
| <b>4</b>  | <b>General information.....</b>                                | <b>7</b>  |
| <b>5</b>  | <b>Application area.....</b>                                   | <b>7</b>  |
| <b>6</b>  | <b>Specific conditions of use ("X" identification) .....</b>   | <b>8</b>  |
| <b>7</b>  | <b>Important information for mounting and maintenance.....</b> | <b>8</b>  |
| <b>8</b>  | <b>Safe operating mode .....</b>                               | <b>12</b> |
| <b>9</b>  | <b>Potential equalization/Grounding .....</b>                  | <b>12</b> |
| <b>10</b> | <b>Electrostatic charging (ESD).....</b>                       | <b>12</b> |
| <b>11</b> | <b>Instructions for zone 20, zone 20/21 applications.....</b>  | <b>13</b> |
| <b>12</b> | <b>Electrical data.....</b>                                    | <b>13</b> |
| <b>13</b> | <b>Mechanical data.....</b>                                    | <b>14</b> |
| <b>14</b> | <b>Thermal data .....</b>                                      | <b>14</b> |

Supplementary documentation:

- Operating Instructions NivoGuide 8100, 3100, 8200
- Quick setup guide NivoGuide 8100, 3100, 8200
- EU type approval certificate TÜV 20 ATEX 266901 X (Document ID: 64004)

Editing status: 2020-03-06

|    |   |
|----|---|
| DE | Sicherheitshinweise<br>für den Einsatz in explosionsgefährdeten Bereichen               |
| EN | Safety instructions<br>for the use in hazardous areas                                   |
| FR | Consignes de sécurité<br>pour une application en atmosphères explosibles                |
| IT | Normative di sicurezza<br>per l'impiego in luoghi con pericolo di esplosione            |
| ES | Instrucciones de seguridad<br>para el empleo en áreas con riesgo de explosión           |
| PT | Normas de segurança<br>para utilização em zonas sujeitas a explosão                     |
| NL | Veiligheidsaanwijzingen<br>voor gebruik op plaatsen waar ontploffingsgevaar kan heersen |
| SV | Säkerhetsanvisningar<br>för användning i explosionsfarliga områden                      |
| DA | Sikkerhedsforskrifter<br>til anvendelse i explosionsfarlig atmosfære                    |
| FI | Turvallisuusohjeet<br>räjähdysvaarallisissa tiloissa käyttöä varten                     |
| EL | Υποδείξεις ασφαλείας<br>για τη χρησιμοποίηση σε περιοχές που υπάρχει κίνδυνος έκρηξης   |

|    |  |
|----|--|
| DE | Die vorliegenden Sicherheitshinweise sind in den Sprachen deutsch, englisch, französisch und spanisch verfügbar. Weitere EU-Landessprachen stellt der Hersteller nach Anforderungen zur Verfügung.             |
| EN | The present safety instructions are available in German, English, French and Spanish. Further EU languages will be provided by the manufacturer upon request.  |
| FR | Les présentes consignes de sécurité sont disponibles dans les langues allemand, anglais, français et espagnol. Le fabricant met d'autres langues de l'Union Européenne à disposition en fonction des demandes. |
| ES | Las presentes instrucciones de seguridad están disponibles en los idiomas alemán, inglés, francés y español. El fabricante pone a disposición según demanda otros idiomas nacionales de la UE.                 |

## 1 Area of applicability

These safety instructions apply to the NivoGuide 8100, 3100, 8200 of type series:

- NivoGuide 8100: NG8100AW/Y\*A/B\*\*1\*\*\* \*\*\*\*\*A/D
- NivoGuide 3100: NG3100AW/T\*A/B\*\*1\*\*\* \*\*\*\*\*A/D
- NivoGuide 8200: NG8200BW/Y\*A/B\*\*1\*\*0 \*\*\*\*\*A/D

With the electronics versions:

- A - Two-wire 4 ... 20 mA/HART
- B - Two-wire 4 ... 20 mA/HART with SIL qualification

According to EU type approval certificate TÜV 20 ATEX 266901 X (certificate number on the type label) and for all instruments with safety instruction 64003.

The classification as well as the respective standards are stated in the EU type approval certificate:

- EN IEC 60079-0: 2018
- EN 60079-31: 2014

Type of protection marking:

- II 1D Ex ta IIIC T\* Da
- II 1/2D Ex ta/tb IIIC T\* Da/Db
- II 1/3D Ex ta/tc IIIC T\* Da/Dc
- II 2D Ex tb IIIC T\* Db

## 2 Important specification in the type code

**NivoGuide 8100 NG8100AW/Y\*A/B\*\*1\*\*\* \*\*\*\*\*A/D**

| Position | Feature   | Description |   |
|----------|---|-------------|---|
| 2        | Certificate   | W           | ATEX II 1D, 1/2D, 1/3D, 2D Ex ta, ta/tb, ta/tc, tb IIIC T*  |
|          |   | Y           | ATEX II 1G, 1/2G, 2G Ex ia IIC T6 ... T1 Ga, Ga/Gb, Gb, II 1D, 1/2D, 1/3D, 2D Ex ta, ta/tb, ta/tc, tb IIIC T*   |
| 3        | Seal / Second line of defense / Process temperature | A           | FKM (SHS EPM 70C3 GLT) / without / -40 ... +80 °C   |
|          |   | D           | FFKM (Kalrez 6375) / without / -20 ... +150 °C  |
|          |   | F           | FKM (SHS FPM 70C3 GLT) / without / -40 ... +150 °C  |
|          |   | G           | FKM (SHS FPM 70C3 GLT) / with / -40 ... +150 °C   |
|          |   | L           | FFKM (Kalrez 6375) / with / -20 ... +200 °C   |
|          |   | M           | EPDM (A+P 70.10-02) / with / -40 ... +150 °C  |
|          |   | N           | Silicone FEP coated (A+P FEP-O-SEAL) / with / -40 ... +150 °C   |
| 4        | Electronics module                                  | P           | FFKM (Kalrez 6375) / with / -20 ... +150 °C   |
|          |   | A           | Two-wire 4 ... 20 mA/HART   |
| 5,6      | Process fitting                                     | B           | Two-wire 4 ... 20 mA/HART with SIL qualification  |
|          |   | **          | Gas-tight threaded connections, pipe connections and industrial flanges acc. to ASME, BS, DIN, EN, GOST, HG/T, JIS, other international, national or industrial standards, regulations or standards, with pressure specifications |

| Position |  | Feature | Description   |
|----------|--|---------|---|
| 8        | Version and length of bracket "L" / Material | E       | exchangeable rod (ø 8 mm) / 316L                                      |
|          |  | F       | exchangeable rod (ø 12 mm) / 316L                                     |
|          |  | B       | exchangeable cable (ø 2 mm) with gravity weight / 316                 |
|          |  | U       | exchangeable cable (ø 4 mm) without weight / 316                      |
|          |  | A       | exchangeable cable (ø 4 mm) with gravity weight / 316                 |
|          |  | K       | Coax (ø 21.3 mm) with single hole / 316L                              |
|          |  | L       | Coax (ø 21.3 mm) with multiple hole / 316L                            |
|          |  | P       | Coax (ø 42.2 mm) with multiple hole / 316L                            |
| 9        | Indicating/adjustment module                 | 0       | without   |
|          |  | A       | mounted; lid with inspection window                                   |
|          |  | F       | without; lid with inspection window                                   |
|          |  | B       | laterally mounted; double chamber housing, lid with inspection window |
| 10       | Length rigid part "L1"                       | 0       | without (version with rod)  |
|          |  | Z       | L1 = customer-specific (version with cable)                           |
| 16       | Housing                                      | A       | Aluminium - single chamber  |
|          |  | D       | Aluminium - double chamber  |

**NivoGuide 3100 NG3100AW/T\*A/B\*\*1\*\*\* \*\*\*\*\*A/D**

| Position |  | Feature | Description   |
|----------|--|---------|---|
| 2        | Certificate                                  | W       | ATEX II 1D, 1/2D, 1/3D, 2D Ex ta, ta/tb, ta/tc, tb IIIC T*  |
|          |  | T       | ATEX II 1/2G, 2G Ex db IIC T6 ... T1 Ga/Gb, Gb, II 1D, 1/2D, 1/3D, 2D Ex ta, ta/tb, ta/tc, tb IIIC T*   |
| 3        | Seal / Process temperature                   | A       | FKM (SHS EPM 70C3 GLT) / -40 ... +80 °C   |
|          |  | B       | EPDM (A+P 70.10-02) / -40 ... +80 °C  |
|          |  | F       | FKM (SHS FPM 70C3 GLT) / -40 ... +150 °C  |
|          |  | K       | FFKM (Kalrez 6375) / -20 ... +200 °C  |
|          |  | H       | EPDM (A+P 70.10-02) / -40 ... +150 °C   |
| 4        | Electronics module                           | A       | Two-wire 4 ... 20 mA/HART   |
|          |  | B       | Two-wire 4 ... 20 mA/HART with SIL qualification  |
| 5, 6     | Process fitting                              | **      | Gas-tight threaded connections, pipe connections and industrial flanges acc. to ASME, BS, DIN, EN, GOST, HG/T, JIS, other international, national or industrial standards, regulations or standards, with pressure specifications |
| 8        | Version and length of bracket "L" / Material | A       | exchangeable cable (ø 4 mm) / 316   |
|          |  | F       | exchangeable cable (ø 6 mm) / 316   |
|          |  | E       | exchangeable steel cable (ø 6 mm with gravity weight / PA coated  |
|          |  | G       | exchangeable steel cable (ø 11 mm with gravity weight / PA coated   |
|          |  | H       | exchangeable rod (ø 16 mm) / 316L   |

| Position |                              | Feature | Description   |
|----------|------------------------------|---------|---|
| 9        | Indicating/adjustment module | 0       | without   |
|          |                              | A       | mounted; lid with inspection window                                   |
|          |                              | F       | without; lid with inspection window                                   |
|          |                              | B       | laterally mounted; double chamber housing, lid with inspection window |
| 16       | Housing                      | A       | Aluminium - single chamber  |
|          |                              | D       | Aluminium - double chamber  |

**NivoGuide 8200 NG8200BW/Y\*A/B\*\*1\*\*0 \*\*\*\*\*A/D**

| Position |   | Feature | Description   |
|----------|---|---------|---|
| 2        | Certificate   | W       | ATEX II 1D, 1/2D, 1/3D, 2D Ex ta, ta/tb, ta/tc, tb IIIC T*  |
|          |   | Y       | ATEX II 1G, 1/2G, 2G Ex ia IIC T6 ... T1 Ga, Ga/Gb, Gb, II 1D, 1/2D, 1/3D, 2D Ex ta, ta/tb, ta/tc, tb IIIC T*   |
| 3        | Seal / Second line of defense / Process temperature | 1       | Ceramic-graphite / with / -196 ... +280 °C  |
|          |   | 2       | Ceramic-graphite / with / -196 ... +400 °C  |
|          |   | 2       | Ceramic-graphite / with / -196 ... +450 °C  |
|          |   | 3       | PEEK-FFKM (Kalrez 6375) / with / -20 ... +250 °C  |
| 4        | Electronics module                                  | A       | Two-wire 4 ... 20 mA/HART   |
|          |   | B       | Two-wire 4 ... 20 mA/HART with SIL qualification  |
| 5,6      | Process fitting                                     | **      | Gas-tight threaded connections, pipe connections and industrial flanges acc. to ASME, BS, DIN, EN, GOST, HG/T, JIS, other international, national or industrial standards, regulations or standards, with pressure specifications |
| 8        | Version and length of bracket "L" / Material        | E       | exchangeable rod (ø 8 mm) / 316L  |
|          |   | H       | exchangeable rod (ø 16 mm) / 316L   |
|          |   | B       | exchangeable cable (ø 2 mm) with gravity weight / 316   |
|          |   | A       | exchangeable cable (ø 4 mm) with gravity weight / 316   |
|          |   | L       | Coax (ø 21.3 mm) with multiple hole / 316L  |
|          |   | P       | Coax (ø 42.2 mm) with multiple hole / 316L  |
| 9        | Indicating/adjustment module                        | 0       | without   |
|          |   | A       | mounted; lid with inspection window   |
|          |   | F       | without; lid with inspection window   |
|          |   | B       | laterally mounted; double chamber housing, lid with inspection window   |
| 16       | Housing   | A       | Aluminium - single chamber  |
|          |   | D       | Aluminium - double chamber  |

Multiple listed characteristics according to the dependencies of the device configuration.

In the following, all above mentioned versions are called NivoGuide 8100, 3100, 8200. If parts of these safety instructions refer only to certain versions, then these will be mentioned explicitly with their type code.

### 3 Different ignition protection types

The NivoGuide 8100, 3100, 8200 can be either used in explosive dust atmospheres or in explosive gas atmospheres.

The operator must specify the selected ignition protection type before installation. The selected ignition protection must be determined by marking it firmly on the identification label of the type plate.

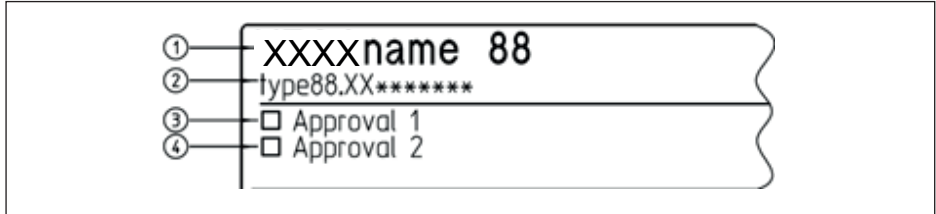

- 1 NivoGuide 8100, 3100, 8200
- 2 Instrument version
- 3 Identification label: Approval in dust ignition protection type e. g. „Ex t“
- 4 Identification label: Approval in Gas ignition protection type e. g. „Ex i“, „Ex d“

If NivoGuide 8100, 3100, 8200 is installed in a gas atmosphere, then the safety instructions and the instructions in the respective certificates must be noted:

| Installation | Approval | Certificate          | Safety instruction |
|--------------|----------|----------------------|--------------------|
| Gas          | "Y"      | TÜV 19 ATEX 248529 X | 61519              |
| Gas          | "T"      | TÜV 19 ATEX 248591 X | 62099              |

### 4 General information

The level measuring instruments NivoGuide 8100, 3100, 8200 as guided radar sensors are used to detect the distance between product surface and sensor by means of high frequency electromagnetic waves in the GHz range. The electronics uses the running time of the signals reflected by the product surface to calculate the distance to the product surface.

The NivoGuide 8100, 3100, 8200 consist of an electronics housing, a process connection element and a sensor, i.e. a measuring cable or a measuring rod. As an option, the display and adjustment module can also be installed in the instrument.

The NivoGuide 8100, 3100, 8200 are suitable for use in areas with combustible, dust-generating bulk solids of explosion groups IIIA, IIIB and IIIC.

The NivoGuide 8100, 3100, 8200 are suitable for applications requiring category 1D (EPL Da), 1/2D (EPL Da/Db), 1/3D (EPL Da/Dc) or 2D (EPL Db) instruments.

### 5 Application area

#### Category 1D (EPL Da instruments)







The NivoGuide 8100, 3100, 8200 with the mechanical fixing element are installed in hazardous areas of zone 20 requiring category 1D (EPL Da) instruments.

#### Category 1/2D or 1/3D (EPL Da/Db or EPL Da/Dc instrument)

The NivoGuide 8100, 3100, 8200 with mechanical fixing element are installed in hazardous areas of zone 21 or zone 22 requiring instruments of category 2D (EPL Db) or 3D (EPL Dc). The mechanical fixing element, process connection element is installed in the separating wall, which separates areas requiring instruments of category 2D (EPL Db) or 3D (EPL Dc). The sensor measuring system is installed in hazardous areas of zone 0 requiring instruments of category 1G (EPL Da).

### Category 2D (EPL Db instruments)

The NivoGuide 8100, 3100, 8200 with the mechanical fixing element are installed in hazardous areas of zone 21 requiring category 2D (EPL Db) instruments.

| VEGA Instrument   | 3D (EPL Dc)   | 2D (EPL Db)   | 1/2D (EPL Da/Db)  | 1D (EPL Da)   |
|---|---|---|---|---|
| Ex Zone 22<br> |  |   |   |   |
| Ex Zone 21<br> |   |  |  |   |
| Ex Zone 20<br> |   |   |   |  |

## 6 Specific conditions of use ("X" identification)

The following overview is listing all special properties of NivoGuide 8100, 3100, 8200, which make a labelling with the symbol "X" behind the certificate number necessary.

### Electrostatic charging (ESD)

You can find the details in chapter "*Electrostatic charging (ESD)*" of these safety instructions.

### Ambient temperature

You can find the details in chapter "*Thermal data*" of these safety instructions.

### Non-grounded, metallic parts

Resistance between aluminium housing to metal measuring point identification plate is  $> 10^9$  Ohm.

The capacitance of the metal measuring point identification plate was measured with 15 pF.

## 7 Important information for mounting and maintenance

### General instructions

The following requirements must be fulfilled for mounting, electrical installation, setup and maintenance of the instrument:

- The staff must be qualified according the respective tasks
- The staff must be trained in explosion protection
- The staff must be familiar with the respectively valid regulations, e.g. planning and installation acc. to IEC/EN 60079-14
- Make sure when working on the instrument (mounting, installation, maintenance) that there is no explosive atmosphere present, the supply circuits should be voltage-free, if possible.
- The instrument has to be mounted according to the manufacturer specifications, the EU type approval certificate and the valid regulations and standards
- Modifications on the instrument can influence the explosion protection and hence the safety
- Modifications must only be carried out by employees authorized by VEGA company
- Use only approved spare parts



- Components for installation and connection not included in the approval documents are only permitted if these correspond technically to the latest standard mentioned on the cover sheet. They must be suitable for the application conditions and have a separate certificate. The special conditions of the components must be noted and if necessary, the components must be integrated in the type test. This applies also to the components already mentioned in the technical description.
- Vessel installations and probable flow must be taken into account

### **Cable and wire entries**

- The NivoGuide 8100, 3100, 8200 must be connected via suitable cable gland or conduit systems that are in conformity with the requirements of the flame proofing and the IP protection and provided with a separate type approval certificate. When connecting NivoGuide 8100, 3100, 8200 to conduit systems, the corresponding sealing facility must be connected directly to the housing.
- The red thread or/dust covers screwed in when the instruments are shipped (depending on the version) must be removed before setup and replaced by cable entries or closing screws suitable for the respective ignition protection type and IP protection.
- Note type and size of the thread: A label with the respective thread name is in the area of the respective thread
- Threads must have no damages
- Cable entries and closing screws should be mounted correctly and according to the safety instructions of the manufacturer to ensure the specified ignition protection type and IP protection rating. When using certified or suitable cable glands, closing screws or plug connections, it is absolutely necessary to note the corresponding certificates/documents. Supplied cable entries or closing screws meet these requirements.
- Unused openings must be closed with plugs suitable for the ignition protection type and IP protection. Supplied plugs meet these requirements.
- Cable or wire entries resp. the closing screws must be tightly screwed into the housing
- The connection cables resp. pipeline sealing facilities must be suitable for the application conditions (e.g. temperature range) of the application
- With surface temperatures > 70 °C, the cables must be suitable for the higher application conditions
- The connection cable of NivoGuide 8100, 3100, 8200 has to be wired fix and in such a way that damages can be excluded.

## Single chamber housing "Ex t"

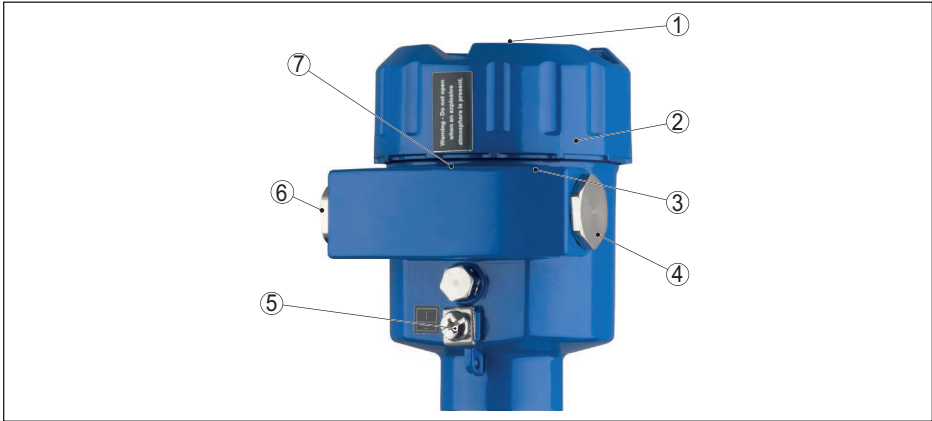

- 1 Lid, optionally with inspection window
- 2 "Ex t" connection compartment with electronics module
- 3 Label: Thread type
- 4 Screw plug
- 5 External ground terminal
- 6 Red threaded or dust protection cap
- 7 Transport protection, replace with installation
- 7 Locking screws of the lid for lid locking

## Double chamber housing "Ex t"

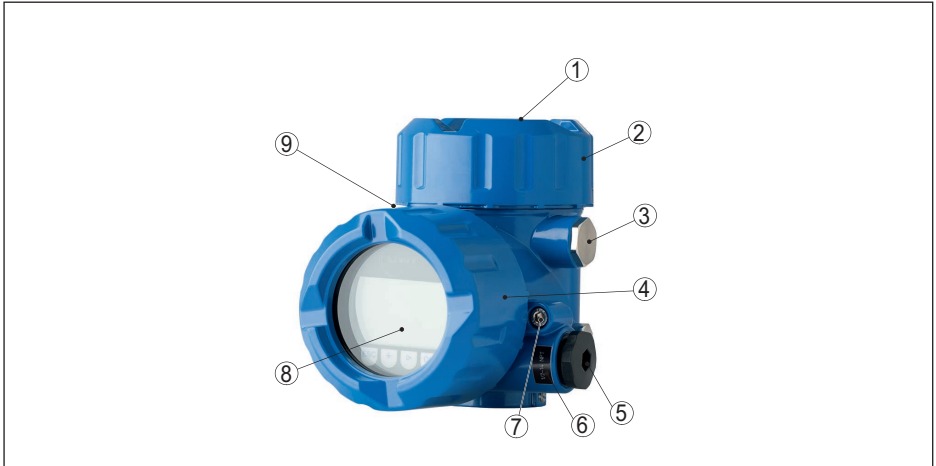

- 1 Lid, optionally with inspection window
- 2 "Ex t" connection compartment with electronics module
- 3 Screw plug
- 4 Connection compartment
- 5 Transport protection, replace with installation  
Red threaded or dust protection cap
- 6 Label: Thread type
- 7 Locking screws of the lid for lid locking
- 8 Lid, optionally with inspection window
- 9 Locking screws of the lid for lid locking

## Mounting

Keep in mind for instrument mounting

- Mechanical damage on the instrument must be avoided
- Mechanical friction must be avoided
- Vessel installations and probable flow must be taken into account
- Process connections separating two areas of different Ex-zones must comply to valid regulations and standards and the protection rating must be in conformity to IEC/EN 60529.
- Close the housing lid (s) up to the stop before starting operating, to ensure the IP protection rating specified on the type label
- Protect the lid against unauthorized opening by unscrewing the locking screw up to the stop. With double chamber housing, you have to protect both lids.

## Maintenance

To ensure the functionality of the device, periodic visual inspection is recommended for:

- Secure mounting
- No mechanical damages or corrosion
- Worn or otherwise damaged cables
- No loose connections of the line connections, equipotential bonding connections
- Correct and clearly marked cable connections

The parts of the NivoGuide 8100, 3100, 8200 being in contact with flammable media during operation must be included in the periodic overpressure test of the plant.

### Dust ignition protection by enclosure "t"

- The terminals for connecting the operating voltage or signal circuits are integrated in the connection compartment with type of protection dust explosion protection by housing "t"
- Cable, wire entries and the closing screws must be certified acc. to ignition protection type dust ignition protection by enclosure "t"
- Cable, wire entries resp. the closing screws in simple construction must not be used
- Separately certified cable and wire entries can determine the permissible ambient temperature range or the temperature classes

### Version with exchangeable cable or rod probe

Only original VEGA cable or rod probes must be mounted to NivoGuide 8100, 3100, 8200. When mounting cable or rod probes, the torques specified in the respective operating instruction manuals must be maintained. The mechanical connection must be ensured.

## 8 Safe operating mode

### General operating conditions

- Do not operate the instrument outside the electrical, thermal and mechanical specifications of the manufacturer
- Use the instrument only in media against which the wetted parts are sufficiently resistant
- Note the relation between process temperature on the sensor/antenna and the permissible ambient temperature on the electronics housing. For permissible temperatures, see the respective temperature tables. See chapter "*Thermal data*".
- If necessary, a suitable overvoltage arrester can be connected in front of the NivoGuide 8100, 3100, 8200
- For assessment and reduction of the explosion risk, valid standards such as for example ISO/EN 1127-1 must be taken into account
- Lids must not be opened if there is a hazardous atmosphere. The housing lids are marked with the warning label:

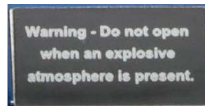

## 9 Potential equalization/Grounding

- Integrate the instruments into the local potential equalisation, e.g. via the internal or external earth terminal
- The potential equalization terminal must be secured against loosening and twisting
- If grounding of the cable screening is necessary, this must be carried out acc. to the valid standards and regulations, e.g. acc. to IEC/EN 60079-14

## 10 Electrostatic charging (ESD)

In case of instrument versions with electrostatically chargeable plastic parts, the danger of electrostatic charging and discharging must be taken into account!

The following parts can charge and discharge:

- Lacquered housing version or alternative special lacquering
- Plastic housing, plastic housing parts
- Metal housing with inspection window
- Plastic process fittings
- Plastic-coated process fittings and/or plastic-coated sensors

- Connection cable for separate versions
- Type label
- Isolated metallic labels (measuring point identification plate)

Take note in case of danger of electrostatic charges:

- Avoid friction on the surfaces
- Do not dry clean the surfaces

The instruments must be mounted/installed in such a way that the following can be ruled out:

- in the case of extremely flammable dusts with a minimum ignition energy of less than 3 mJ, the device must not be used in areas where intensive electrostatic charging processes can be expected
- electrostatic charges during operation, maintenance and cleaning.
- process-related electrostatic charges, e.g. by measuring media flowing

The warning label indicates danger:

WARNING - POTENTIAL ELECTROSTATIC  
CHARGING HAZARD - SEE INSTRUCTIONS

## 11 Instructions for zone 20, zone 20/21 applications

In hazardous areas, the instrument, sensor measuring system in zone 20 should only be operated under atmospheric conditions:

- Temperature: -20 ... +60 °C.
- Pressure: 80 ... 110 kPa (0.8 ... 1.1 bar)
- Air with normal oxygen content, normally 21 %

The surface temperature in zone 20 must not be higher than 2/3 of the min. ignition temperature of the dust cloud and the ignition temperature of the dust layer, 75 K plus a safety distance acc. to standard IEC/EN 60079-14. The operator has to make sure that the max. permissible surface temperature will not be exceeded. The parts of the sensor which during operation are in contact with flammable products, must be integrated in the periodic overpressure test of the plant.

If no explosive mixtures or additional application conditions are certified or supplementary measures such as e.g. according to ISO/EN 1127-1 taken, then the instruments can be also operated according to the manufacturer specification outside atmospheric conditions.

If there is a risk of dangerous potential differences inside zone 20, then suitable measures for circuits in zone 20 must be taken, e.g. according to the requirements of IEC/EN 60079-14.

## 12 Electrical data

For the electronic versions A/B it must be observed, that when installed as EPL Da device in zone 20, the maximum power at the sensor must be limited to the  $P_{max} \leq 2 \text{ W}$ .

### NivoGuide 8100, 3100, 8200, single chamber housing

| Supply and signal circuit in the electronics and connection compartment: |  |
|--|--|
| Terminals 1[+], 2[-]   | $U = 9.6 \dots 35 \text{ V DC}$<br>$U_m = 253 \text{ V AC/DC}$<br>$I \leq 3.5 \dots 22.5 \text{ mA}$ (with superimposed HART signal) |

## NivoGuide 8100, 3100, 8200, double chamber housing

| Supply and signal circuit in the connection compartment: |   |
|--|---|
| Terminals 1[+], 2[-]                                     | $U = 9.6 \dots 35 \text{ V DC}$<br>$U_m = 253 \text{ V AC/DC}$<br>$I \leq 3.5 \dots 22.5 \text{ mA}$ (with superimposed HART signal)  |
| Display and adjustment circuit:                          |   |
| Spring contacts in the connection compartment            | Only for connection to the NivoGuide display and adjustment module or for service purposes the interface adapter, if it is ensured that no explosive atmosphere is present. |

The circuits of NivoGuide 8100, 3100, 8200 are galvanically separated from ground.

The metallic parts of NivoGuide 8100, 3100, 8200 are electrically connected with the earth terminals.

## 13 Mechanical data

The following mechanical data are valid for all housing and electronics versions.

| Mechanical data  |   |
|--|---|
| Ground terminal (connection cross-section)   | $\geq 4 \text{ mm}^2$   |
| Housing protection rating  | IP66  |
| <ul style="list-style-type: none"> <li>● Materials</li> <li>● Max. tensile load on the cable or rod probe</li> <li>● Potential connections and electrical separating measures in the instrument</li> <li>● Electromechanical data</li> <li>● Electrical protective measures</li> </ul> | Are described in the operating instructions NivoGuide 8100, 3100, 8200 in chapter "Technical data". |

## 14 Thermal data

The following ambient temperature ranges and surface temperatures apply to applications requiring equipment in equipment group III (explosive dust atmospheres):

### On the sensor, limited by seal

| Permissible process temperature on the sensor:              |   |
|---|---|
| NivoGuide NG8100A*AA/B**1*** *****                          | -40 ... +80 °C                                |
| NivoGuide NG8100A*D/F/PA/B**1*** *****                      | -20 ... +150 °C                               |
| NivoGuide NG8100A*G/M/NA/B**1*** *****                      | -40 ... +150 °C                               |
| NivoGuide NG8100A*LA/B**1*** *****                          | -20 ... +200 °C                               |
| NivoGuide NG3100A*A/BA/B**1*** *****                        | -40 ... +80 °C                                |
| NivoGuide NG3100A*F/HA/B**1*** *****                        | -40 ... +150 °C                               |
| NivoGuide NG3100A*KA/B**1*** *****                          | -20 ... +200 °C                               |
| NivoGuide NG8200B*1A/B**1**0 *****                          | -196 ... +280 °C                              |
| NivoGuide NG8200B*2A/B**1**0 *****                          | -196 ... +450 °C (+400 °C)                    |
| NivoGuide NG8200B*3A/B**1**0 *****                          | -20 ... +250 °C                               |
| Permissible ambient temperature on the electronics housing: | $-40 \text{ °C} \leq T_a \leq +60 \text{ °C}$ |

**Surface temperature increases**

**NivoGuide 8100, 3100, 8200, Installation in Zone 20, applications requiring EPL Da devices:**

|   |                                   |
|---|-----------------------------------|
| NivoGuide 8100, 3100, 8200, $P_{max} < 2 \text{ W}$ | Process/ambient temperature +86 K |
|---|-----------------------------------|

**NivoGuide 8100, 3100, 8200, Installation in Zone 20/21, 20/22 or 21, applications requiring EPL Da/Db, Da/Dc and Db devices:**

|                            |  |
|----------------------------|--|
| NivoGuide 8100, 3100, 8200 | Ambient temperature +38 K<br>( $38 \text{ K} = (41.1 \text{ K/W} \times 828 \text{ mW}) + 4 \text{ K}$ ) |
|----------------------------|--|

The probes may only be used in EPL Da; Da/Db; Da/Dc and EPL Db applications if atmospheric conditions are present (temperatures: see tables above and pressure from 0.8 bar to 1.1 bar).

If there is no explosive atmosphere, the permissible operating temperatures and pressures must be taken from the manufacturer specifications (operating instructions).

If the sensors (measuring cable, measuring rod) are operated at temperatures higher than those listed in the table above, measures must be taken to prevent the risk of ignition from hot surfaces.

**Protection rating**

|   |                     |
|---|---------------------|
| On the sensor, category 1D or 2D              | IP68                |
| On the electronics housing, category 1D or 2D | IP66/IP68 (0.2 bar) |

**Temperature derating for process temperatures up to +150 °C, +200 °C, +250 °C, +280 °C and +450 °C**

**Versions for process temperatures up to +150 °C**

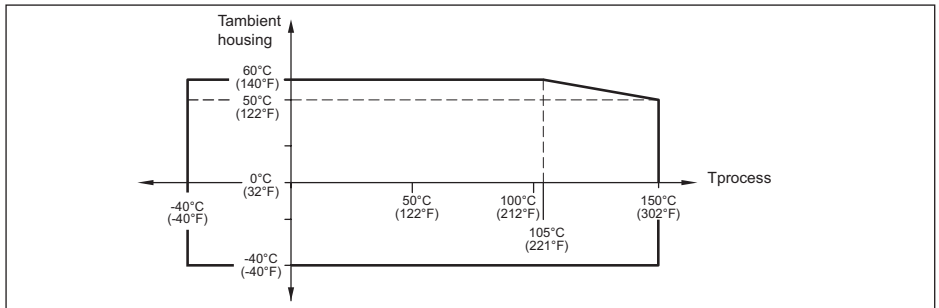

**Versions for process temperatures up to +200 °C**

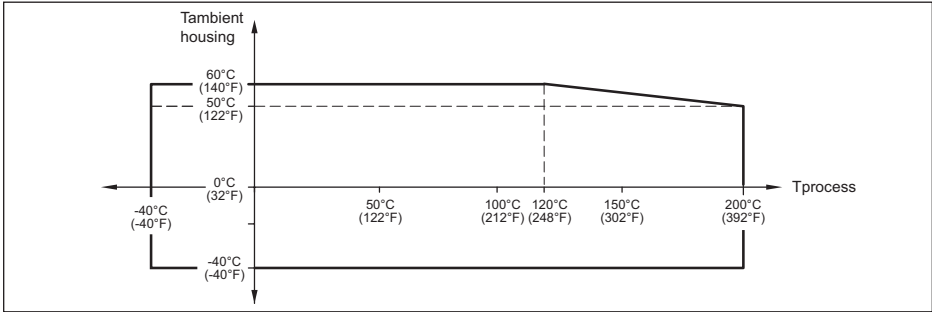

**Versions for process temperatures up to +250 °C**

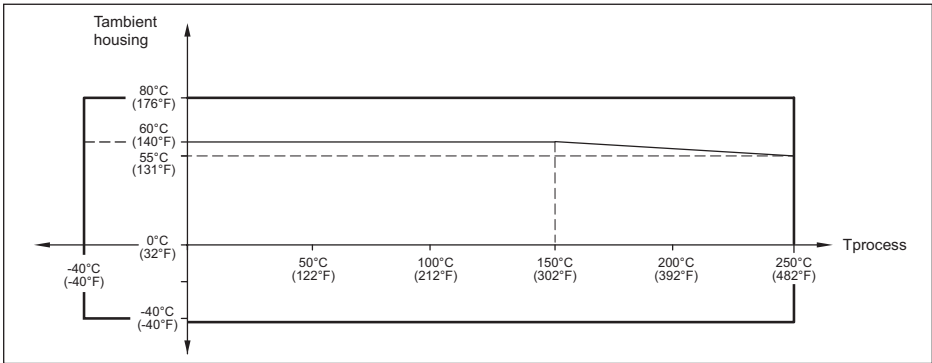

**Versions for process temperatures up to +280 °C**

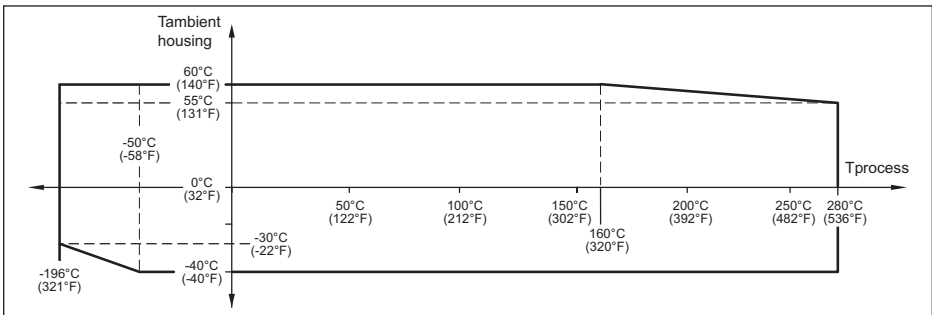



Versions for process temperatures up to +450 °C

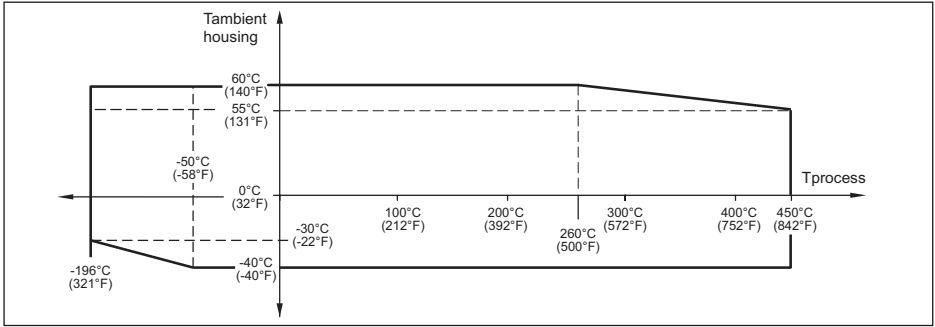





Printing date:

All statements concerning scope of delivery, application, practical use and operating conditions of the sensors and processing systems correspond to the information available at the time of printing.  
Subject to change without prior notice

**Technical support**

Please contact your local sales partner (address at [www.uwt.de](http://www.uwt.de)). Otherwise please contact us:

UWT GmbH  
Westendstraße 5  
87488 Betzigau  
Germany

Phone +49 831 57123-0  
Fax +49 831 76879  
[info@uwt.de](mailto:info@uwt.de)  
[www.uwt.de](http://www.uwt.de)

64003-EN-200508