

L1219B

Universal Explosion-proof LED Lighting



Net Weight: 9.5 kg (20.9 lb)



LED Tower

Zone 1	Zone 2	Zone 21	Zone 22	IP68	NEMA 6P
---------------	---------------	----------------	----------------	-------------	----------------

Protection

- Ex d IIB + H₂ T5...T4 Gb
- Ex tb IIIC T90°C...T105°C Db
- ⓂII 2 G Ex d IIB + H₂ T5...T4 Gb
- ⓂII 2 D Ex tb IIIC T90°C...105°C Db

Standards

- IEC 60079-0
- IEC 60079-1
- IEC 60079-31
- EN 60079-0
- EN 60079-1
- EN 60079-31

Light Features

- 360° illumination angle
- Applicable to high temperature environment
- Ideal for replacing traditional HPS Lighting

Technical Data

Rated Voltage (±10%)	110V / 220V AC				
Watts (±10%)	50W / 60W / 70W / 80W				
Amps	50W 110V: 0.45A, 220V: 0.23A / 60W 110V: 0.55A, 220V: 0.27A 70W 110V: 0.64A, 220V: 0.32A / 80W 110V: 0.73A, 220V: 0.36A				
Color of LED Light	3000K (Warm White) / 5000K (Cool White)				
Ambient Temperature	-20°C ~ +40°C, T5				
Power Factor	cos ≥ 0.9				
CRI	Cool White ≥ 70 / Warm White ≥ 80				
Lumen (±10%)	COB	50W	60W	70W	80W
	3000K	4500 lm	5400 lm	6300 lm	7200 lm
	5000K	5000 lm	6000 lm	7000 lm	8000 lm
Beam Angle	X-110° / Y-110°				
Frequency	50 / 60 Hz				
Degree of Protection	IP68 / NEMA 6P				
Material	<ul style="list-style-type: none"> • Enclosure Aluminum alloy • Glass Tempered glass 				
LED Service Life	60,000 hrs				
Entrance Thread	G 3/4" × 4 (Tall top cover) G 3/4" × 1 (Short top cover)				

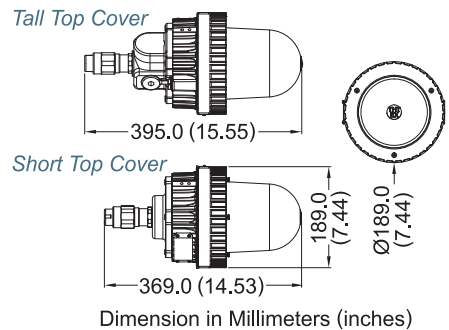

Optical Report

Polar Luminous Intensity Distribution

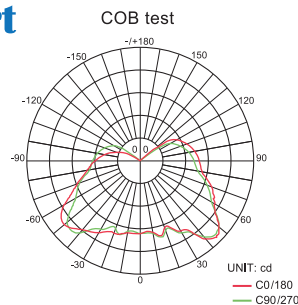

Luminous Intensity Distribution Diagram

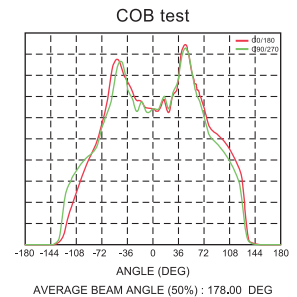



Model Code

THT-EX	1219	C	E	C	B	5	1	C90
---------------	-------------	----------	----------	----------	----------	----------	----------	------------

Brand, THT=TOP HI-TECH CO., LTD.
 Model Name, 1219=Model L1219
 C.C.T., C=Cool White, W=Warm White
 Voltage, C=110V, E=220V
 Type of LED carrier, C=Cylinder
 Type of Top Cover, A=Tall type, B=Short type
 LED quantity
 Wattage, 1=50W, A=60W, 70W, 80W
 Mounting bracket type
 W25/90=Wall Mount 25°/90°
 H25/90=Hanging Mount 25°/90°
 S25/90=Stanchion 25°/90°
 P30=Pendant
 C90=Ceiling

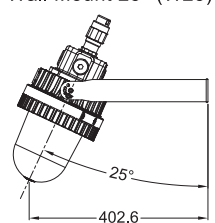
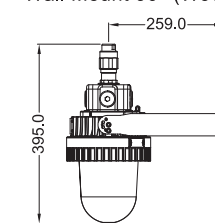
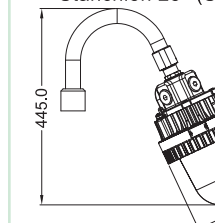
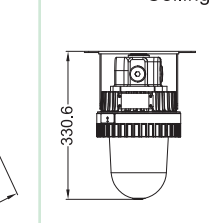
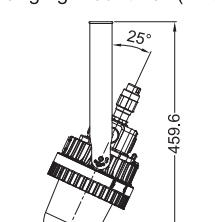
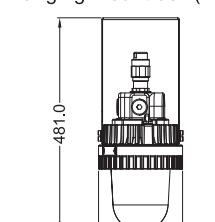
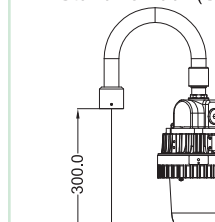
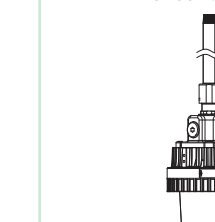
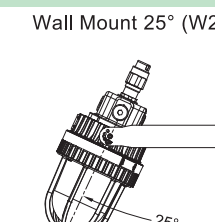
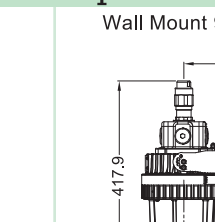
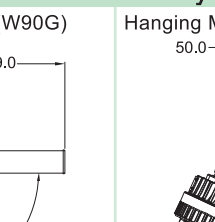
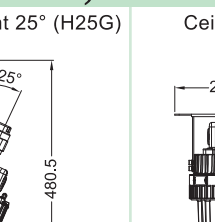
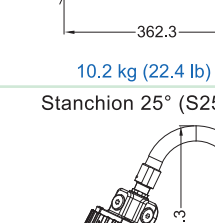
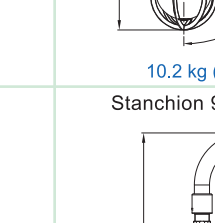
Mounting Option & Dimensions (All in mm)

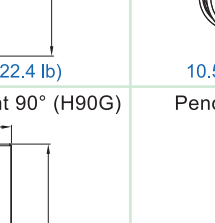
Tall Top Cover (Standard Product)			
Wall Mount 25° (W25)  10.0 kg (22.0 lb)	Wall Mount 90° (W90)  10.0 kg (22.0 lb)	Stanchion 25° (S25)  10.5 kg (23.1 lb)	Ceiling (C90)  10.9 kg (24.0 lb)
Hanging Mount 25° (H25)  10.0 kg (22.0 lb)	Hanging Mount 90° (H90)  10.0 kg (22.0 lb)	Stanchion 90° (S90)  10.6 kg (23.4 lb)	Pendant (P30)  10.0 kg (22.0 lb)
Tall Top Cover (With Accessory "Guard")			
Wall Mount 25° (W25G)  10.2 kg (22.4 lb)	Wall Mount 90° (W90G)  10.2 kg (22.4 lb)	Hanging Mount 25° (H25G)  10.2 kg (22.4 lb)	Ceiling (C90G)  10.5 kg (23.1 lb)
Stanchion 25° (S25G)  10.7 kg (23.6 lb)	Stanchion 90° (S90G)  10.8 kg (23.8 lb)	Hanging Mount 90° (H90G)  10.2 kg (22.4 lb)	Pendant (P30G)  10.2 kg (22.4 lb)

Mounting Option & Dimensions (All in mm)

Short Top Cover (Standard Product)

<p>Wall Mount 25° (W25)</p> <p>259.0</p> <p>25°</p> <p>9.4 kg (20.7 lb)</p>	<p>Wall Mount 90° (W90)</p> <p>259.0</p> <p>369.0</p> <p>9.4 kg (20.7 lb)</p>	<p>Pendant (P30)</p> <p>9.4 kg (20.7 lb)</p>
<p>Hanging Mount 25° (H25)</p> <p>25°</p> <p>466.98</p> <p>9.4 kg (20.7 lb)</p>	<p>Hanging Mount 90° (H90)</p> <p>173.0</p> <p>482.89</p> <p>9.4 kg (20.7 lb)</p>	<p>Stanchion 25° (S25)</p> <p>415.68</p> <p>25°</p> <p>10.3 kg (22.7 lb)</p>

Short Top Cover (With Accessory "Guard")

<p>Wall Mount 25° (W25G)</p> <p>259.0</p> <p>25°</p> <p>9.6 kg (21.1 lb)</p>	<p>Wall Mount 90° (W90G)</p> <p>259.0</p> <p>391.0</p> <p>9.6 kg (21.1 lb)</p>	<p>Stanchion 25° (S25G)</p> <p>436.0</p> <p>25°</p> <p>10.5 kg (23.1 lb)</p>
<p>Hanging Mount 25° (H25G)</p> <p>25°</p> <p>259.0</p> <p>489.0</p> <p>9.6 kg (21.1 lb)</p>	<p>Hanging Mount 90° (H90G)</p> <p>505.0</p> <p>9.6 kg (21.1 lb)</p>	<p>Pendant (P30G)</p> <p>9.6 kg (21.1 lb)</p>

Optional Accessory

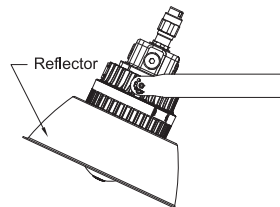
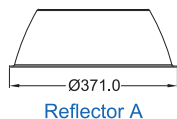

Applicable Area

- Oil Refinery Complex
- Petrochemical Complex
- Painting Facility
- Transporting Nature Gas
- Transporting Liquefied Petroleum Gas
- Offshore Platform (Oil and Natural Gas)