

# AUTOMATION PRODUCTS GROUP, INC.

**Operator's Manual**

## **RPM Series Float Level Sensors**

Rev. E, 08/16  
Doc. 9002103



**Automation Products Group, Inc.**

Tel: 1/888/525-7300 • Fax: 1/435/753-7490 • [www.apgsensors.com](http://www.apgsensors.com) • E-mail: [sales@apgsensors.com](mailto:sales@apgsensors.com)

## Table of Contents

*Warranty*.....3  
*Description*.....4  
*Installation* ..... 5-7  
*Wiring*..... 8-9  
*Analog Calibration* ..... 10-12  
*Inspection & Maintenance*.....12  
*Specifications* ..... 13-14  
*CSA Certificate of Compliance* ..... 15-18

- **Warranty and Warranty Restrictions**

This product is covered by APG's warranty to be free from defects in material and workmanship under normal use and service of the product for 24 months. For a full explanation of our Warranty, please visit <https://www.apgsensors.com/about-us/terms-conditions>. Contact Technical Support to receive a Return Material Authorization before shipping your product back.

Scan the QR code below to read the full explanation of our Warranty on your tablet or smartphone.



## • Description

The RPM utilizes reed switches in the instrument's stem and a permanent magnet in the float. As the float rises or falls with the level of the liquid, the magnet inside the float acts on the reed switches inside the stem and provides a resistive-chain output. The RPM is also available with optional electronics that convert the resistance output into a 4-20mA signal.

## • Handling of the Intrinsically Safe RPM Series

Electrical ratings; 12 to 24 Volts DC, 4 - 20 ma

Exia Class I Division 1; Groups C, D T3C (Max. Temp. 85°C)  
 $V_{max} = 30VDC$ ,  $I_{max} = 130ma$ ,  $C_i = 3nF$ ,  $L_i = 0uH$

ATEX Directive:  0344

Sira 11ATEX2136X

 II 1G Ex ia IIB T3 Ga

$-40^{\circ}C \leq T_a \leq +85^{\circ}C$

$U_i \leq 30 V$ ,  $I_i \leq 130 mA$ ,  $P_i \leq 1 W$ ,  $C_i \leq 3 nF$ ,  $L_i \leq 0 mH$

IECEX CSA 16.0018X

Ex ia IIB T3 Ga

$-40^{\circ}C \leq T_a \leq +85^{\circ}C$

All repairs and adjustments of the RPM must be made by the factory. To modify, disassemble, or alter the RPM on site is strictly prohibited. Do not loosen any joints, with the exception of the housing cover for electrical connection.

## • Handling of the Explosion-Proof RPM Series

Electrical ratings; 5 to 24 Volts DC, 100 ma



Class I Division 1 Groups C & D (Max. Temp. 40°C.)

Class I Division 2; Groups C & D (Max. Temp. 85°C.)

Class I Zone 1; Ex d IIB / AEx d IIB T3

Probe may be wired as a Non-Incendive device in Class I Division 2 Groups C & D areas.

All repairs and adjustments of the RPM must be made by the factory. To modify, disassemble, or alter the RPM on site is strictly prohibited. Do not loosen any joints, with the exception of the housing cover for electrical connection.

- **Handling of the Explosion-Proof RPM Series**
- **Installation**

### **- Unpacking -**

When unpacking the instrument, exercise care not to subject the instrument to mechanical shock. After unpacking, visually inspect the instrument for damage.

### **- Environment -**

The RPM series instruments should be installed in an areas indoors or outdoors which meets the following conditions:

1. The ambient temperature does not exceed  $-40^{\circ}\text{C}$  to  $85^{\circ}\text{C}$  ( $-40^{\circ}\text{F}$  to  $+185^{\circ}\text{F}$ ) for Class I Divison 2 or  $-40^{\circ}\text{C}$  to  $40^{\circ}\text{C}$  ( $-40^{\circ}\text{F}$  to  $+104^{\circ}\text{F}$ ) for Class I Divison 1.

NOTE: It is recommended that a sun shield be installed over the housing if exposed to direct sunlight.

2. The medium temperature does not exceed  $-40^{\circ}\text{C}$  to  $85^{\circ}\text{C}$  ( $-40^{\circ}\text{F}$  to  $+185^{\circ}\text{F}$ ) for Class I Divison 2 or  $-40^{\circ}\text{C}$  to  $40^{\circ}\text{C}$  ( $-40^{\circ}\text{F}$  to  $+104^{\circ}\text{F}$ ) for Class I Divison 1.

3. Relative humidity up to 100%

4. Pollution Degree 2

5. Measurment Category II

6. Altitude 2000 m or less.

7. Locate the sensor away from strong magnetic fields such as those produced by motors, transformers, solenoid valves, etc.

8. The medium is free from metallic substances and other foreign matter.

9. No corrosive gases such as  $\text{NH}_3$ ,  $\text{SO}_2$ ,  $\text{Cl}_2$ , etc.

10. No excessive vibration

11. Ample space for maintenance and inspection.

## • Installation

### - Location -

Do not locate the RPM sensor near inlets/outlets. If there is surface wave action, then it may be advisable to use a stilling tube. If a stilling tube is used, drill vent holes in the tube and use a spacer bottom mounting bracket to assure the probe is centered in the tube and the can move without interference.

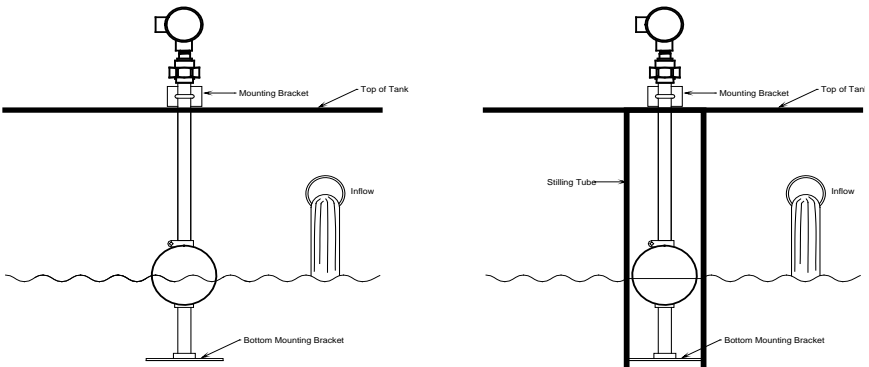

Wave action will cause signal bounce. Use a stilling tube to provide a smooth output signal.

### - Mounting -

The RPM probe must be secured top and bottom. The bottom of the probe can be secured using stainless steel bottom mounting bracket (p/n 135396) or similar stainless steel mounting method. This bracket is fixed to the bottom of the vessel and the probe stem seats inside of it.

*Mounting in this way will prevent any lateral movement and prevent the float from coming off of stem during use.*

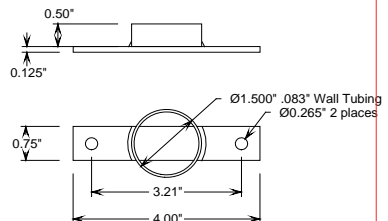

Part Number 135396

## 1. Clamp Mounting

The most common method of mounting the top of the RPM probe is by clamping it into place. Top stainless steel mounting bracket part number 125603 or similar can be used. The U-bolt is tightened around the 1.25" stainless steel stem just below the union. The bracket is permanently mounted to the top of the tank. It is important to keep mounting hardware clear of float travel.

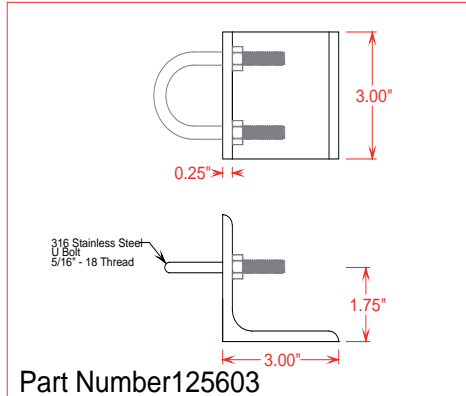

## 2. Flange Mounting

Provide the compatible mating flange on the tank and install using a suitable gasket.

## 3. Plug Mounting

Provide the compatible female boss on the tank and install the RPM with a suitable gasket, O-ring, or thread tape.

*Note: Assure that all metal parts are earthed. It must be assured that the sensor tube is connected to the potential equalizing system and is not isolated from it due to, for instance, tightening means.*

*Warning: Because the enclosure of the electronics/terminals of the Float Level Sensor is made of aluminium, if it is mounted in an area where the use of category 1 G apparatus is required, it must be installed such, that even in the event of rare incidents, ignition sources due to impact and friction sparks are excluded. In the event that the polyurethane float is used the nonconductive surface of the float may be charged by nonconductive media, it has to be assured that the media is electrostatically conductive.*

# • Intrinsically Safe Wiring

REVISIONS			
ZONE KEY	DESCRIPTION	CHANGE ORDER	DATE
—	IS Update to Sira marking type	CO—1897	4/11/11
			K. Reed

Installation in Class I Division 1 Groups C and D  
 Installation in  II IG Ex ia IIB T3 Ga Tamb-40 to +B5C

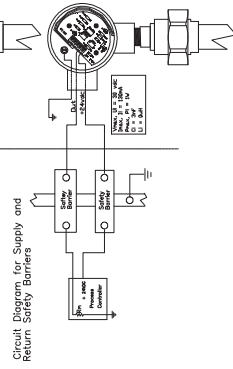
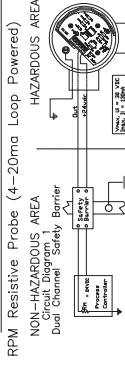

- Install in accordance with CE/NEC articles 504, 505 and ISA RPT2.6 Recommended Practices for the Installation of Intrinsically Safe Circuits.
- WARNING: SUBSTITUTION OF COMPONENTS MAY IMPAIR INTRINSIC SAFETY (AVERTISSEMENT: LA SUBSTITUTION DE COMPOSANTS PEUT COMPROMETTRE LA SÉCURITÉ INTRINSÈQUE.)
- WARNING: EXPLOSION HAZARD – DO NOT DISCONNECT EQUIPMENT UNLESS POWER HAS BEEN SWITCHED OFF OR AREA IS KNOWN TO BE NONHAZARDOUS (AVERTISSEMENT – DE DÉCONNECTER L'ÉQUIPEMENT: COUPER LE COURANT DU S'ASSURER QUE L'EMPLACEMENT EST BIEN NON DANGEREUX).
- WARNING: POTENTIAL ELECTROSTATIC CHARGING HAZARD – Do not clean feet with a dry cloth

Do Not Alter without proper approval from the ATEX Authorized Person.

APPROVALS		DATE	 APGH Approved Product Group For RPM Series IS Hazardous Installation Drawing For RPM Series Installation with Probe (RPM U.S. IMA)
APP	REVISED	DATE	
APP	REVISED	2/02/2002	THIS DRAWING IS THE PROPERTY OF APG SENSORS. IT IS NOT TO BE REPRODUCED OR TRANSMITTED IN ANY FORM OR BY ANY MEANS, ELECTRONIC OR MECHANICAL, INCLUDING PHOTOCOPYING, RECORDING, OR BY ANY INFORMATION STORAGE AND RETRIEVAL SYSTEM, WITHOUT THE WRITTEN PERMISSION OF APG SENSORS. IF CHANGED, IT IS SUBJECT TO BEING SUPERSEDED BY A LATER REVISION. IN ANY EVENT, THE USER AGREES TO INDEMNIFY AND HOLD APG SENSORS HARMLESS FROM AND AGAINST ALL LIABILITY, DAMAGES AND LOSSES, INCLUDING REASONABLE ATTORNEY'S FEES, ARISING FROM OR RESULTING FROM THE USE OF THIS DRAWING IN ANY MANNER, IN ANY JURISDICTION, BY THE USER OR ANY OTHER PARTY, WHETHER OR NOT SUCH LIABILITY, DAMAGES AND LOSSES ARE FORESEEN OR UNFORESEEN.
APP	REVISED	07/16/2003	
APP	REVISED	07/16/2003	THIS ANGLE PRODUCTION PER IMA 19234 (01/99)
DATE	BY	FOR	DATE OF ZONE KEY DATE OF ZONE KEY DATE OF ZONE KEY DATE OF ZONE KEY
DATE	BY	FOR	DATE OF ZONE KEY DATE OF ZONE KEY DATE OF ZONE KEY DATE OF ZONE KEY
DATE	BY	FOR	DATE OF ZONE KEY DATE OF ZONE KEY DATE OF ZONE KEY DATE OF ZONE KEY
DATE	BY	FOR	DATE OF ZONE KEY DATE OF ZONE KEY DATE OF ZONE KEY DATE OF ZONE KEY

Note: Insure that all metal parts are earthed.



Automation Products Group, Inc.



# Explosion-Protected Wiring

ZONE REV	DESCRIPTION	REVISIONS CHANGE ORDER	DATE	APPROVED
-	F6 Add Zone Listing	C0-	1961	K. Reed

Installation in Class I Division 2 Groups C and D, Max. Temp. 85°C  
 Installation in Class I Division 1 Groups C and D, Max. Temp. 40°C  
 Installation in Class I Zone 1; Ex d IIB / AEx d IIB T3

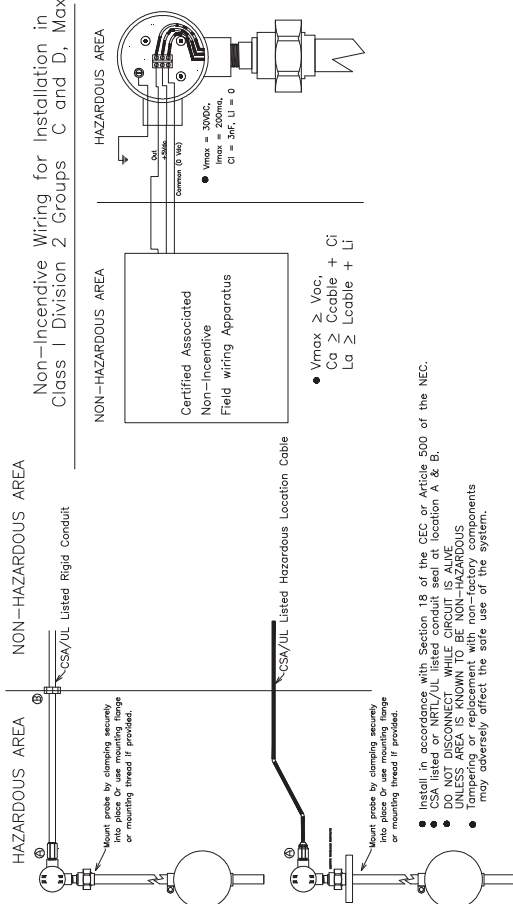

- $V_{max} \geq V_{oc}$
- $C_a \geq C_{cable} + C_i$
- $L_a \geq L_{cable} + L_i$

Non-Incendive Wiring for Installation in Class I Division 2 Groups C and D, Max. Temp. 85°C

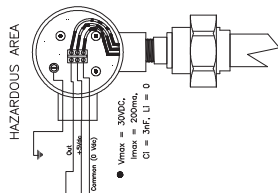

NON-HAZARDOUS AREA

Certified Associated Non-Incendive Field wiring Apparatus

HAZARDOUS AREA

Install in accordance with Section 18 of the CEC or Article 500 of the NEC.

- CSA listed or NRTL/UL listed conduit seal at location A & B.
- CONDUIT SHALL BE OF THE SAME TYPE AS THE CABLE BEING INSTALLED.
- UNLESS AREA IS KNOWN TO BE NON-HAZARDOUS
- Tampering or replacement with non-factory components may adversely affect the safe use of the system.

APPROVALS		DATE	DESIGN APPROVED	
K. Reed	7/25/2002	7/25/2002	APGPH	
<small>UNLESS OTHERWISE SPECIFIED:</small> DIMENSIONS ARE IN INCHES. DIMENSIONS ARE IN MILLIMETERS. DIMENSIONS ARE IN MILLIMETERS. DIMENSIONS ARE IN MILLIMETERS. DIMENSIONS ARE IN MILLIMETERS. DIMENSIONS ARE IN MILLIMETERS. DIMENSIONS ARE IN MILLIMETERS. DIMENSIONS ARE IN MILLIMETERS.			<small>FOR HAZARDOUS INSTALLATION DRAWING</small> IS Hazardous Installation Drawing For RPM Resilient Couin Probe For RPM Resilient Couin Probe	
REV	DATE	BY	CHK	APP
C	02/4/00	RNH/JM	RNH/JM	APGPH
TITLE				DATE
RPM Series				11/18/15
PART				1 OF 1
SHEET				1 OF 1

## • Analog Calibration Procedure (for models equipped with 4-20 mA conversion board)

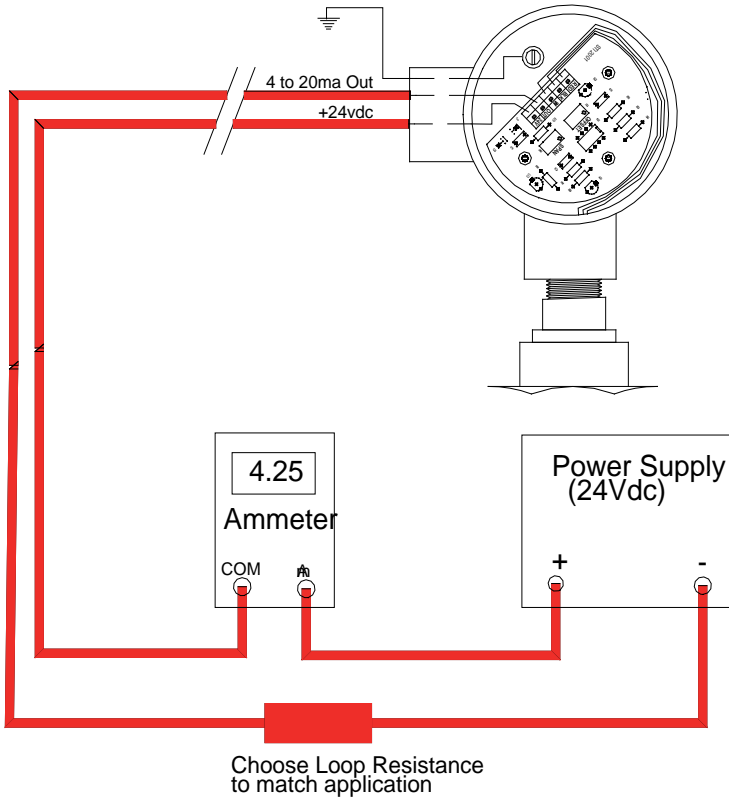

1. Set DC power supply voltage at 24VDC.
2. Connect Ammeter in series with loop.
3. Move float to the bottom position
4. Adjust the Offset potentiometer until meter reads 4ma
5. Move float to top position
6. Adjust the Span potentiometer until the meter reads 20ma.
7. Repeat steps 3 - 6 for final adjustment.

• **Analog Calibration Procedure**  
(for models equipped with 4-20 mA conversion board)

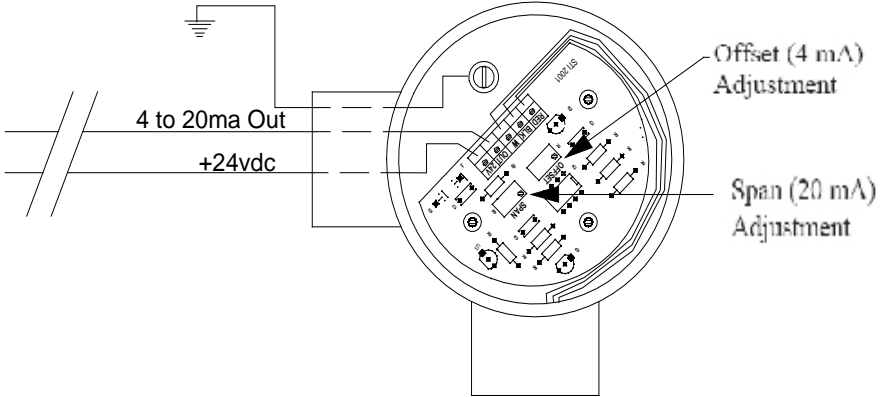

*Analog Board is Encapsulated*



## Wiring for Voltage Operation

Red and Black connect to each end of a resistive chain. The white wire is the voltage output that is connected to different points on the resistive chain by reed switches.

**Red** +5 to +24 VDC  
**Black** Ground  
**White** Voltage Out

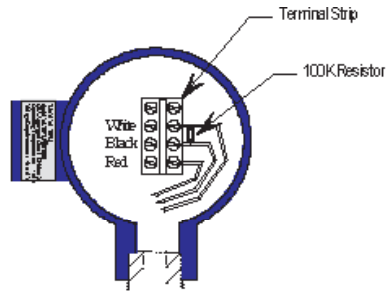

## • Inspection and Maintenance

Periodic inspection is necessary to keep your RPM unit in good working order.

**CAUTION! Do not remove the housing cover until the atmosphere is determined to be safe, and the power supplied to the unit is turned off.**

Keep the sensor clean.

If sediment or other foreign matter is trapped between the stem and the float, detection errors may be caused.

Inspect probe shaft and bottom weld for any possible holes or leaks. If possible leak is detected remove probe from service and send to factory for repair.

Inspect O-ring on cover to make sure that it is in good condition. Never leave the housing cover off. If the cover becomes damaged or is misplaced, replace immediately.

## • RPM Specifications

Resolution	+/- 0.39 in. (+/- 10mm.)
Maximum Length	288 in. (7.3M)
Maximum Process Temperature	-40°C to 85°C (-40°F to 185°F)
Probe Material	316 L SS.
Float Material	Polyurethane Foam
Housing Material	Aluminium Modified 359 Alloy Silicon (Si) 8.5 - 9.5 % Magnesium (Mg) 68 - .85% Copper (Cu) .30% max (3/10 of 1%) Iron (Fe) .30% max (3/10 of 1%)
Housing Rating	NEMA 4

### Hazardous Ratings:

#### **Intrinsically Safe**

Electrical ratings: 12 to 24 Volts DC, 4 - 20 ma

Exia Class I Division 1; Groups C, D T3C (Max. Temp. 85°C)

Vmax = 30VDC, Imax = 130ma, Ci = 3nF, Li = 0uH

ATEX Directive:



Sira 11ATEX2136 X



II 1G Ex ia IIB T3 Ga

-40°C ≤ Ta ≤ +85 °C

Ui ≤ 30 V, Ii ≤ 130 mA, Pi ≤ 1 W, Ci ≤ 3 nF, Li ≤ 0 mH

IECEX CSA 16.0018X

Ex ia IIB T3 Ga

-40°C ≤ Ta ≤ +85 °C

**Explosion-Proof**

Electrical ratings: 5 to 24 Volts DC, 100 ma



Class I Division 1; Groups C &amp; D (Max. Temp. 40°C.)

Class I Division 2; Groups C & D (Max. Temp 85°C).  
Class I Zone 1; Ex d IIB / AEx d IIB T3**Non-Incendive**

Electrical ratings; 5 to 24 Volts DC, 100 ma

Class I Division 2; Groups C & D (Max. Temp 85°C).  
Vmax = 30 VDC, Imax = 200 ma, Ci = 3nF, Li = 0



# Certificate of Compliance

**Certificate:** 2167400 (237484)

**Master Contract:** 237484

**Project:** 70022836

**Date Issued:** 2016-01-22

**Issued to:** Automation Products Group Inc  
1025 West 1700 North  
Logan, Utah 84321  
USA

**Attention:** Karl Reid

*The products listed below are eligible to bear the CSA Mark shown with adjacent indicators 'C' and 'US' for Canada and US or with adjacent indicator 'US' for US only or without either indicator for Canada only.*



**Issued by:** John Yam  
John Yam

## **PRODUCTS**

CLASS - C225205 - PROCESS CONTROL EQUIPMENT

CLASS - C225285 - PROCESS CONTROL EQUIPMENT-Certified to US Standards

CLASS - C225802 - PROCESS CONTROL EQUIPMENT-For Hazardous Locations-

CLASS - C225882 - PROCESS CONTROL EQUIPMENT-For Hazardous Locations - Certified to US Standards

CLASS - C225803 - PROCESS CONTROL EQUIPMENT - Intrinsicly Safe and Non-Incendive Systems - For Hazardous Locations

CLASS - C225883 - PROCESS CONTROL EQUIPMENT-Intrinsicly Safe and Non-Incendive-Systems-For Hazardous Locations-Certified to U.S. Standards

CLASS - C225804 - PROCESS CONTROL EQUIPMENT-Intrinsicly Safe, Entity - For Hazardous Locations-

CLASS - C225884 - PROCESS CONTROL EQUIPMENT - Intrinsicly Safe, Entity-- For Hazardous Locations - Certified to US Standards

**CLASS 2252 05** - PROCESS CONTROL EQUIPMENT

**CLASS 2252 85** - PROCESS CONTROL EQUIPMENT (Certified to U.S. Standards)

Float Level Sensors, permanently connected, indoor and outdoor use, max. operating ambient 85°C:

- Models FLXx and FLRx, rated 220 V, 0.5 A;
- Models RPMx, RPXx and RPEX, rated 5 - 15 Vdc, 100 mA, or 12 to 24 Vdc, 4-20mA;
- Model RPAX, rated 12 to 24 Vdc, 4-20mA;



**Certificate:** 2167400  
**Project:** 70022836

**Master Contract:** 237484  
**Date Issued:** 2016-01-22

- Model CTR-0100 (P/Ns 110101 and 110101-0001), Loop Powered 4-20mA Module, rated 4-20mA output is 12 to 24 Vdc.

Note: The above models are Pollution Degree 2, Measurement Category II.

Notes for Models FLXx, FLRx, RPMx, RPAX, RPXx, RPEx:

1. The "x" in the Model designations may be any alpha-numeric character, to denote minor mechanical options, not affecting safety. Refer to Illustration 28 for Model designator and suffix details.
2. The equipment is intended to be installed as required by the applicable electrical code (CEC, NEC) and as specified by the manufacturer's Installation Instructions.
3. The circuit board P/N STF-CTR-01\*\* from the Model RPMx Probe may be supplied as a component part where the suitability of the final installation will be inspected by the authority with jurisdiction in the area where installed.
4. The installation will be inspected by the authority with jurisdiction in the area where installed.

**CLASS 2258 02 - PROCESS CONTROL EQUIPMENT - FOR HAZARDOUS LOCATIONS**

**CLASS 2258 82 - PROCESS CONTROL EQUIPMENT - FOR HAZARDOUS LOCATIONS, U.S. Requirements**

**Class I, Division 1, Groups C, and D**

- Float Level Sensors, model FLXx, rated 220 V, 0.5 A, max. or rated 24Vdc, 0.5A, max., and model RPMx and RPXx, rated 5 - 24 Vdc, 100mA or 12 to 24 Vdc, 4-20mA; operating ambient 40°C.

**Class I, Zone 1, Ex d, IIB T3**

**Class I, Zone 1, AEx d, IIB T3**

- Float Level Sensors, model FLXx, rated 24 Vdc, 0.5 A, max., and model RPMx and RPXx, rated 5 - 24 Vdc, 100mA or 12 to 24 Vdc, 4-20mA; operating ambient 40°C.

Notes for Models FLXx, RPMx, RPXx:

1. The "x" in the Model designations may be any alpha-numeric character, to denote minor mechanical options, not affecting safety.
2. The equipment is intended to be installed as required by the applicable electrical code (CEC, NEC) and as specified by the manufacturers Installation Instructions.
3. The installation will be inspected by the authority with jurisdiction in the area where installed.

**Class I, Division 2, Groups C, and D**

- Float Level Sensor model FLXx, rated 220 V, 0.5 A, model RPMx and RPXx, rated 5 - 15 Vdc, 100mA, or rated 12 to 24 Vdc, 4-20mA, and model RPAX, rated 12 to 24 Vdc, 4-20mA; max; operating ambient 85°C.

Notes for Models FLXx, RPMx, RPAX, RPXx:





**Certificate:** 2167400  
**Project:** 70022836

**Master Contract:** 237484  
**Date Issued:** 2016-01-22

1. The "x" in the Model designations may be any alpha-numeric character, to denote minor mechanical options, not affecting safety.
2. The equipment is intended to be installed as required by the applicable electrical code (CEC, NEC) and as specified by the manufacturers Installation Instructions.
3. The installation will be inspected by the authority with jurisdiction in the area where installed.

**CLASS 2258 03 - PROCESS CONTROL EQUIPMENT - INTRINSICALLY SAFE AND NON INCENDIVE SYSTEMS - FOR HAZARDOUS LOCATIONS**

**CLASS 2258 83 - PROCESS CONTROL EQUIPMENT - INTRINSICALLY SAFE AND NON INCENDIVE SYSTEMS - FOR HAZARDOUS LOCATIONS, CERTIFIED TO U.S. STANDARDS**

**Class I, Division 2, Groups C, and D**

- Float Level Sensor model RPMx and RPXx, rated 5 - 15 Vdc, 100mA, or rated 12 to 24 Vdc, 4-20mA, and model RPax, rated 12 to 24 Vdc, 4-20mA; max; operating ambient 85°C. Field wiring is non-incendive when installed per drawings 9001415, 9001932 and 9002023 respectively.

Notes for Models RPMx, RPax, RPXx:

1. The "x" in the Model designations may be any alpha-numeric character, to denote minor mechanical options, not affecting safety.
2. The equipment is intended to be installed as required by the applicable electrical code (CEC, NEC) and as specified by the manufacturers Installation Instructions.
3. The installation will be inspected by the authority with jurisdiction in the area where installed.

**CLASS 2258 04 - PROCESS CONTROL EQUIPMENT - INTRINSICALLY SAFE, ENTITY - FOR HAZARDOUS LOCATIONS**

**CLASS 2258 84 - PROCESS CONTROL EQUIPMENT - INTRINSICALLY SAFE, ENTITY - FOR HAZARDOUS LOCATIONS, U.S. Requirements**

**Class I, Division 1, Groups C, and D**

- Float Level Sensors, model RPMx, RPax, RPXx and model CTRx loop powered 24Vdc, 4-20mA converter module, max. operating ambient 85°C; Temperature Code rating T3C; Intrinsically Safe when connected as per drawing 9001414, 9001423 and 9001930 with the following Entity Parameters: Vmax = 30V, Imax = 130mA, Ci = 3nF, Li = 0uH.

Notes for Models RPMx, RPax and RPXx:

1. The "x" in the Model designations may be any alpha-numeric character, to denote minor mechanical options, not affecting safety.
2. The equipment is intended to be installed as required by the applicable electrical code (CEC, NEC) and as specified by the manufacturers Installation Instructions.
3. The installation will be inspected by the authority with jurisdiction in the area where installed.



**Certificate:** 2167400  
**Project:** 70022836

**Master Contract:** 237484  
**Date Issued:** 2016-01-22

#### APPLICABLE REQUIREMENTS

CSA Standards C22.2 No. 0-10	- General Requirements - Canadian Electrical Code, Part II
CSA Standards C22.2 No. 30-M1987	- Explosion-Proof Enclosures for Use in Class I Hazardous Locations
CAN/CSA C22.2 No. 61010-1-12	- Safety Requirements for Electrical Equipment for Measurement, Control, and Laboratory Use, Part 1: General Requirements
CSA Standards C22.2 No. 157-M1992	- Intrinsically Safe and Non-Incendive Equipment for Use in Hazardous Locations
CSA Standards C22.2 No. 213-M1987	- Non-Incendive Electrical Equipment for Use in Class I, Division 2 Hazardous Locations
CSA Standards C22.2 No. 60079-0:15	- Explosive atmospheres – Part 0: Equipment – General requirements
CSA Standards C22.2 No. 60079-1:11	- Explosive atmospheres – Part 1: Equipment protection by flameproof enclosures “d”
UL 61010-1 (3 <sup>rd</sup> Edition)	- Safety Requirements for Electrical Equipment for Measurement, Control, and Laboratory Use - Part 1: General Requirements
UL 913, Eighth Edition	- Intrinsically Safe Apparatus and Associated Apparatus for use in Class I, II, III, Division 1, Hazardous (Classified) Locations
UL1203, Fifth Edition	- Explosion-Proof and Dust-Ignition-Proof Electrical Equipment for Use in Hazardous (Classified) Locations
UL/ISA 60079-0, Sixth Edition	- Explosive atmospheres – Part 0: Equipment – General requirements
UL/ISA 60079-1, Seventh Edition	- Explosive Atmospheres – Part 1: Equipment Protection by Flameproof Enclosures “d”
FM 3611, December 2004	- Nonincendive Electrical Equipment for Use in Class I and II, Divisions 1 and 2 Hazardous (Classified) Locations



### Supplement to Certificate of Compliance

**Certificate:** 2167400 (237484)

**Master Contract:** 237484

*The products listed, including the latest revision described below, are eligible to be marked in accordance with the referenced Certificate.*

#### Product Certification History

Project	Date	Description
70022836	2016-01-22	Update Report 2167400 to include alternate welding method for model RPMx with update 4 drawings, and revise the applicable standards to the latest edition.
2629489	2013-11-19	Update to report 2167400 to add approval for Class I Zone 1 Ex d IIB; AEx d IIB for the Voltage and 4-20ma versions of the RPM and RPX probes as well as the FLX probe limited to 24VDC maximum operating voltage.
2167400	2009-11-16	Create new report from 156365-1140498 and evaluate the non-hazardous locations listed models to CSA/UL 61010-1 as required by Notice 7. Additional component updates and corrections made.

#### History

The following history has been transferred from MC156365 Report 1140498:

1140498 - Nov 2, 2000 - Model FR25x, Float Level Sensor, Model LR29x, Float Level Sensor.

1186512 - Apr 20, 2001 - Update to 1140498 to Change Model Designations From ToLR29x RPMxFR25x FLXx.

1225158 - July 17, 2001 - Update to include alternative UL/CSA reed switches.

1237109 - Sept 4, 2001 - Update to include alternative construction of Model RPMx.

1280884 - May 16, 2002 - Update to include 24 Vdc, loop powered 4-20mA converter board and replace jumper board with jumper wire.

1324024 - August 28, 2002 - Update RPM Level probe to I.S. Requirements.

1384694 - January 20, 2003 - Update to include RPX, RPE, FLR sensors and change ambient to 85°C.

1458115 - July 30, 2003 - Update FLX Float Level Sensor to Class I Division 1 Groups C, & D ambient 40°C. Update to include alternative UL/CSA reed switch.

1517864 - 2004/02/17 - Update RPM for Class I, Div 1. Also add CRTx - Intrinsically-safe for Class I, Div 1.

1663709 - 2005/05/25 - Update report to include: addition of RPA, CTR-0100 surface mount components, RPX as explosionproof, non-incendive field wiring for RPM and RPX and revised drawings.

**EU Declaration of Conformity**

**Manufacturer's Name:** Automation Products Group Inc.  
**Address:** 1025 West 1700 North  
 Logan, UT 84321  
 Tel: (435) 753-7300  
 Fax: (435) 753-7490  
 Email: [sales@apgsensors.com](mailto:sales@apgsensors.com)  
 Web: [www.apgsensors.com](http://www.apgsensors.com)

*Declares that the product:*

**Product Name:** Float Level Sensor – Model RPM-...

*Conforms to:*

**ATEX Directive 2014/34/EU**

- **EU Type Examination Certificate:** Sira 11ATEX2136X  
 Dekra 0344

Sira Certification Service, Rake Lane, Eccleston, Chester, CH4 9JN, England

**Description of Equipment or Protective System:**

The equipment measures a level and provides a 4-20mA output signal proportional to the measured level.

Series: RPM

*Conforms to the following Standards*

EN 60079-0:2012  
 EN 60079-26:2015  
 EN 60079-11:2012

**Markings:** ATEX: Ex II 1G Ex ia IIB T3 Ga

**Supplementary Information:**

This Declaration of Conformity is issued under the sole responsibility of the manufacturer. The described product complies with the Applicable European Directives and relevant sections of the Applicable International Standards. The signature on this document authorizes the distinctive European mark to be applied to the equipment described.

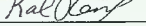
**Authorized Signature:**   
 Karl Reid, Product Line Manager

## Notes

## Notes

# Notes

# AUTOMATION PRODUCTS GROUP, INC.



***Automation Products Group, Inc.***

Tel: 1/888/525-7300

1/435/753-7300

Fax: 1/435/753-7490

e-mail: [sales@apgsensors.com](mailto:sales@apgsensors.com)

[www.apgsensors.com](http://www.apgsensors.com)

Automation Products Group, Inc.

1025 W. 1700 N.

Logan, UT 84321