

NivoGuide® 8100

Two-wire 4 ... 20 mA/HART

Coax probe

With SIL qualification

TDR sensor for continuous level and interface measurement of liquids



Technical information / Instruction manual



Document ID: 61893



Contents

1	About this document	4
1.1	Function	4
1.2	Target group	4
1.3	Symbols used.....	4
2	For your safety	5
2.1	Authorised personnel	5
2.2	Appropriate use.....	5
2.3	Warning about incorrect use.....	5
2.4	General safety instructions	5
2.5	EU conformity.....	6
2.6	SIL qualification according to IEC 61508.....	6
2.7	NAMUR recommendations	6
2.8	Installation and operation in the USA and Canada	6
3	Product description	8
3.1	Configuration.....	8
3.2	Principle of operation.....	9
3.3	Packaging, transport and storage.....	11
3.4	Accessories.....	11
4	Mounting	12
4.1	General instructions	12
4.2	Mounting instructions	13
5	Connecting to power supply	16
5.1	Preparing the connection	16
5.2	Connecting.....	17
5.3	Wiring plan, single chamber housing.....	18
5.4	Wiring plan, double chamber housing	19
6	Functional safety (SIL)	21
6.1	Objective	21
6.2	SIL qualification.....	21
6.3	Application area	21
6.4	Safety concept of the parameterization	22
6.5	Setup process	23
7	Set up with the display and adjustment module	26
7.1	Insert display and adjustment module	26
7.2	Adjustment system	27
7.3	Parameter adjustment - Extended adjustment.....	29
7.4	Saving the parameterisation data.....	49
8	Diagnostics and servicing	50
8.1	Maintenance	50
8.2	Diagnosis memory	50
8.3	Status messages.....	50
8.4	Rectify faults.....	53
8.5	Exchanging the electronics module.....	56
8.6	How to proceed if a repair is necessary.....	57
9	Dismount	58

9.1	Dismounting steps.....	58
9.2	Disposal	58
10	Supplement	59
10.1	Technical data	59
10.2	Dimensions	68
10.3	Trademark	71

**Safety instructions for Ex areas**

Take note of the Ex specific safety instructions for Ex applications. These instructions are attached as documents to each instrument with Ex approval and are part of the operating instructions.

Editing status: 2019-07-30

1 About this document

1.1 Function

This operating instructions provides all the information you need for mounting, connection and setup as well as important instructions for maintenance, fault rectification, the exchange of parts and the safety of the user. Please read this information before putting the instrument into operation and keep this manual accessible in the immediate vicinity of the device.

1.2 Target group

This operating instructions manual is directed to trained personnel. The contents of this manual must be made available to the qualified personnel and implemented.

1.3 Symbols used



Information, note, tip: This symbol indicates helpful additional information and tips for successful work.



Note: This symbol indicates notes to prevent failures, malfunctions, damage to devices or plants.



Caution: Non-observance of the information marked with this symbol may result in personal injury.



Warning: Non-observance of the information marked with this symbol may result in serious or fatal personal injury.



Danger: Non-observance of the information marked with this symbol results in serious or fatal personal injury.



Ex applications

This symbol indicates special instructions for Ex applications.



List

The dot set in front indicates a list with no implied sequence.



Action

This arrow indicates a single action.



Sequence of actions

Numbers set in front indicate successive steps in a procedure.



Battery disposal

This symbol indicates special information about the disposal of batteries and accumulators.

2 For your safety

2.1 Authorised personnel

All operations described in this documentation must be carried out only by trained, qualified personnel authorised by the plant operator.

During work on and with the device, the required personal protective equipment must always be worn.

2.2 Appropriate use

NivoGuide 8100 is a sensor for continuous level measurement.

You can find detailed information about the area of application in chapter "*Product description*".

Operational reliability is ensured only if the instrument is properly used according to the specifications in the operating instructions manual as well as possible supplementary instructions.

2.3 Warning about incorrect use

Inappropriate or incorrect use of this product can give rise to application-specific hazards, e.g. vessel overflow through incorrect mounting or adjustment. Damage to property and persons or environmental contamination can result. Also, the protective characteristics of the instrument can be impaired.

2.4 General safety instructions

This is a state-of-the-art instrument complying with all prevailing regulations and directives. The instrument must only be operated in a technically flawless and reliable condition. The operator is responsible for the trouble-free operation of the instrument. When measuring aggressive or corrosive media that can cause a dangerous situation if the instrument malfunctions, the operator has to implement suitable measures to make sure the instrument is functioning properly.

During the entire duration of use, the user is obliged to determine the compliance of the necessary occupational safety measures with the current valid rules and regulations and also take note of new regulations.

The safety instructions in this operating instructions manual, the national installation standards as well as the valid safety regulations and accident prevention rules must be observed by the user.

For safety and warranty reasons, any invasive work on the device beyond that described in the operating instructions manual may be carried out only by personnel authorised by the manufacturer. Arbitrary conversions or modifications are explicitly forbidden. For safety reasons, only the accessory specified by the manufacturer must be used.

To avoid any danger, the safety approval markings and safety tips on the device must also be observed and their meaning read in this operating instructions manual.

2.5 EU conformity

The device fulfils the legal requirements of the applicable EU directives. By affixing the CE marking, we confirm the conformity of the instrument with these directives.

The EU conformity declaration can be found on our homepage.

Electromagnetic compatibility

Instruments in four-wire or Ex-d-ia version are designed for use in an industrial environment. Nevertheless, electromagnetic interference from electrical conductors and radiated emissions must be taken into account, as is usual with class A instruments according to EN 61326-1. If the instrument is used in a different environment, the electromagnetic compatibility to other instruments must be ensured by suitable measures.

2.6 SIL qualification according to IEC 61508

The Safety Integrity Level (SIL) of an electronic system is used to assess the reliability of integrated safety functions.

For detailed specification of the safety requirements, multiple SIL levels are specified according to safety standard IEC 61508. You can find detailed information in chapter "*Functional safety (SIL)*" of the operating instructions.

The instrument meets the specifications of IEC 61508: 2010 (Edition 2). It is qualified for single-channel operation up to SIL2. The instrument can be used homogeneously redundant up to SIL3 in multi-channel architecture with HFT 1.

2.7 NAMUR recommendations

NAMUR is the automation technology user association in the process industry in Germany. The published NAMUR recommendations are accepted as the standard in field instrumentation.

The device fulfils the requirements of the following NAMUR recommendations:

- NE 21 – Electromagnetic compatibility of equipment
- NE 43 – Signal level for fault information from measuring transducers
- NE 53 – Compatibility of field devices and display/adjustment components
- NE 107 – Self-monitoring and diagnosis of field devices

For further information see www.namur.de.

2.8 Installation and operation in the USA and Canada

This information is only valid for USA and Canada. Hence the following text is only available in the English language.

Installations in the US shall comply with the relevant requirements of the National Electrical Code (ANSI/NFPA 70).

Installations in Canada shall comply with the relevant requirements of the Canadian Electrical Code

A Class 2 power supply unit has to be used for the installation in the USA and Canada.

3 Product description

3.1 Configuration

Type label

The type label contains the most important data for identification and use of the instrument:

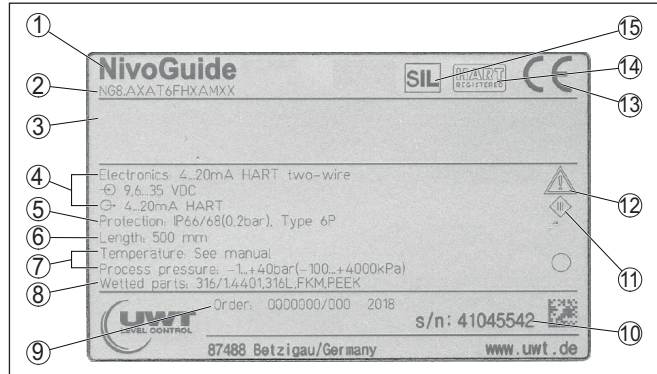

Fig. 1: Layout of the type label (example)

- 1 Instrument type
- 2 Product code
- 3 Approvals
- 4 Power supply and signal output, electronics
- 5 Protection rating
- 6 Probe length (measurement accuracy optional)
- 7 Process and ambient temperature, process pressure
- 8 Material wetted parts
- 9 Order number
- 10 Serial number of the instrument
- 11 Symbol of the device protection class
- 12 Reminder to observe the instrument documentation
- 13 Notified authority for CE marking
- 14 Approval directives
- 15 Marking of the safety function in SIL

Scope of this operating instructions

This operating instructions manual applies to the following instrument versions:

- Hardware from 1.0.0
- Software from 1.2.0
- DTM from version 1.67.2

Versions

The instrument and the electronics version can be determined via the product code on the type label as well as on the electronics.

- Standard electronics: Type FX80H.-SIL

Scope of delivery

The scope of delivery encompasses:

- Sensor
- Optional accessory
- Documentation

- Quick setup guide NivoGuide 8100
- Instructions for optional instrument features
- Ex-specific "Safety instructions" (with Ex versions)
- If necessary, further certificates

Information:

Optional instrument features are also described in this operating instructions manual. The respective scope of delivery results from the order specification.

3.2 Principle of operation

Application area

The NivoGuide 8100 is a level sensor with coax probe for continuous level or interface measurement, suitable for applications in liquids.



Due to the qualification up to SIL2 or homogeneous redundant up to SIL3 (IEC 61508) the NivoGuide 8100 is suitable for the use in safety-instrumented systems (SIS).

The safety function (SIF) can be a monitoring of the max. or min. level or a combination of both.

Functional principle - level measurement

High frequency microwave pulses are guided along a steel cable or a rod. Upon reaching the product surface, the microwave pulses are reflected. The running time is evaluated by the instrument and output as level.

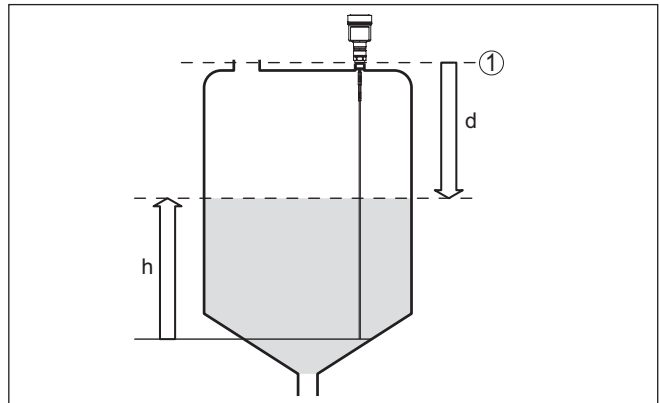

Fig. 2: Level measurement

1 Sensor reference plane (seal surface of the process fitting)

d Distance to the level

h Height - Level

Functional principle - interface measurement

High frequency microwave impulses are guided along a steel cable or rod. Upon reaching the product surface, a part of the microwave impulses is reflected. The other part passes through the upper product and is reflected by the interface. The running times to the two product layers are processed by the instrument.

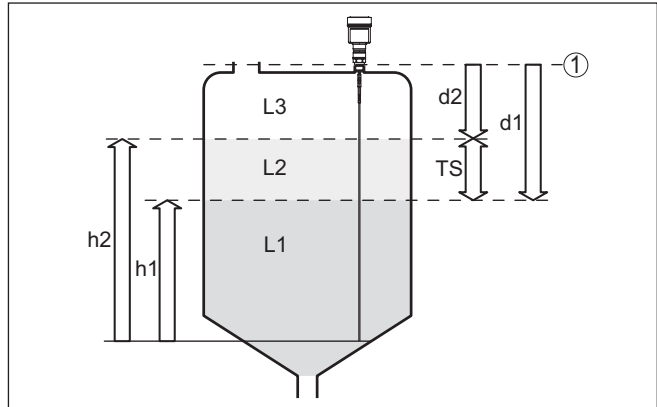

Fig. 3: Interface measurement

1 Sensor reference plane (seal surface of the process fitting)

d1 Distance to the interface

d2 Distance to the level

TS Thickness of the upper medium ($d1 - d2$)

h1 Height - Interface

h2 Height - Level

L1 Lower medium

L2 Upper medium

L3 Gas phase

Prerequisites for interface measurement

Upper medium (L2)

- The upper medium must not be conductive
- The dielectric constant of the upper medium or the actual distance to the interface must be known (input required). Min. dielectric constant: 1.6.
- The composition of the upper medium must be stable, no varying products or mixtures
- The upper medium must be homogeneous, no stratifications within the medium
- Min. thickness of the upper medium 50 mm (1.97 in)
- Clear separation from the lower medium, emulsion phase or detritus layer max. 50 mm (1.97 in)
- If possible, no foam on the surface

Lower medium (L1)

- The dielectric constant must be 10 higher than the dielectric constant of the upper medium, preferably electrically conductive. Example: upper medium dielectric constant 2, lower medium at least dielectric constant 12.

Gas phase (L3)

- Air or gas mixture
- Gas phase - dependent on the application, gas phase does not always exist ($d2 = 0$)

Output signal	<p>The instrument is always preset to the application "<i>Level measurement</i>".</p> <p>For the interface measurement, you can select the requested output signal with the setup.</p>
Packaging	<p>3.3 Packaging, transport and storage</p> <p>Your instrument was protected by packaging during transport. Its capacity to handle normal loads during transport is assured by a test based on ISO 4180.</p> <p>The packaging consists of environment-friendly, recyclable cardboard. For special versions, PE foam or PE foil is also used. Dispose of the packaging material via specialised recycling companies.</p>
Transport	<p>Transport must be carried out in due consideration of the notes on the transport packaging. Nonobservance of these instructions can cause damage to the device.</p>
Transport inspection	<p>The delivery must be checked for completeness and possible transit damage immediately at receipt. Ascertained transit damage or concealed defects must be appropriately dealt with.</p>

Storage	<p>Up to the time of installation, the packages must be left closed and stored according to the orientation and storage markings on the outside.</p> <p>Unless otherwise indicated, the packages must be stored only under the following conditions:</p> <ul style="list-style-type: none">● Not in the open● Dry and dust free● Not exposed to corrosive media● Protected against solar radiation● Avoiding mechanical shock and vibration
Storage and transport temperature	<ul style="list-style-type: none">● Storage and transport temperature see chapter "<i>Supplement - Technical data - Ambient conditions</i>"● Relative humidity 20 ... 85 %

Lifting and carrying	<p>With instrument weights of more than 18 kg (39.68 lbs) suitable and approved equipment must be used for lifting and carrying.</p>
-----------------------------	--

3.4 Accessories

The instructions for the listed accessories can be found in the download area on our homepage.

Display and adjustment module	<p>The display and adjustment module is used for measured value indication, adjustment and diagnosis.</p>
--------------------------------------	---

Flanges	<p>Screwed flanges are available in different versions according to the following standards: DIN 2501, EN 1092-1, BS 10, ASME B 16.5, JIS B 2210-1984, GOST 12821-80.</p>
----------------	---

4 Mounting

4.1 General instructions

Screwing in

On devices with a threaded fitting, the hexagon on the process fitting must be tightened with a suitable wrench.

See chapter "*Dimensions*" for wrench size.



Warning:

The housing or the electrical connection may not be used for screwing in! Depending on the device version, tightening can cause damage, e. g. to the rotation mechanism of the housing.

Protection against moisture

Protect your instrument against moisture ingress through the following measures:

- Use a suitable connection cable (see chapter "*Connecting to power supply*")
- Tighten the cable gland or plug connector
- Lead the connection cable downward in front of the cable entry or plug connector

This applies mainly to outdoor installations, in areas where high humidity is expected (e.g. through cleaning processes) and on cooled or heated vessels.



Note:

Make sure that the degree of contamination specified in chapter "*Technical data*" meets the existing ambient conditions.



Note:

Make sure that during installation or maintenance no moisture or dirt can get inside the instrument.

To maintain the housing protection, make sure that the housing lid is closed during operation and locked, if necessary.

Cable glands

Metric threads

In the case of instrument housings with metric thread, the cable glands are screwed in at the factory. They are sealed with plastic plugs as transport protection.

You have to remove these plugs before electrical connection.

NPT thread

In the case of instrument housings with self-sealing NPT threads, it is not possible to have the cable entries screwed in at the factory. The free openings for the cable glands are therefore covered with red dust protection caps as transport protection. The dust protection caps do not provide sufficient protection against moisture.

Prior to setup you have to replace these protective caps with approved cable glands or close the openings with suitable blind plugs.

Process conditions



Note:

For safety reasons, the instrument must only be operated within the permissible process conditions. You can find detailed information on

the process conditions in chapter "*Technical data*" of the operating instructions or on the type label.

Make sure before mounting that all parts of the instrument exposed to the process are suitable for the existing process conditions.

These are mainly:

- Active measuring component
- Process fitting
- Process seal

Process conditions in particular are:

- Process pressure
- Process temperature
- Chemical properties of the medium
- Abrasion and mechanical influences

4.2 Mounting instructions

Installation position

In vessels with conical bottom it can be advantageous to mount the sensor in the center of the vessel, as measurement is then possible nearly down to the lowest point of the bottom. Keep in mind that measurement all the way down to the tip of the probe may not be possible. The exact value of the min. distance (lower dead zone) is stated in chapter "*Technical data*".

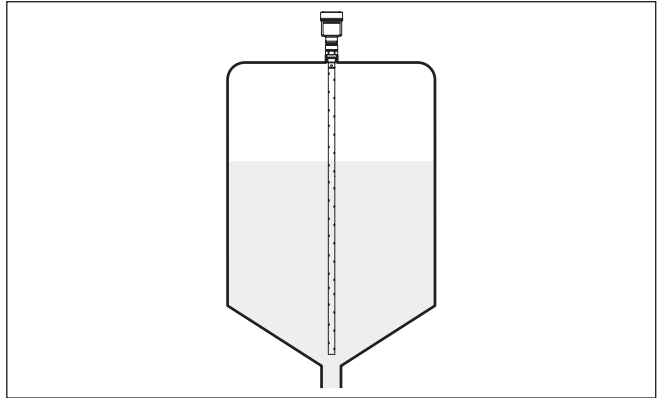

Fig. 4: Vessel with conical bottom

Welding work

Before beginning the welding work, remove the electronics module from the sensor. By doing this, you avoid damage to the electronics through inductive coupling.

Inflowing medium

Do not mount the instruments in or above the filling stream. Make sure that you detect the product surface, not the inflowing product.

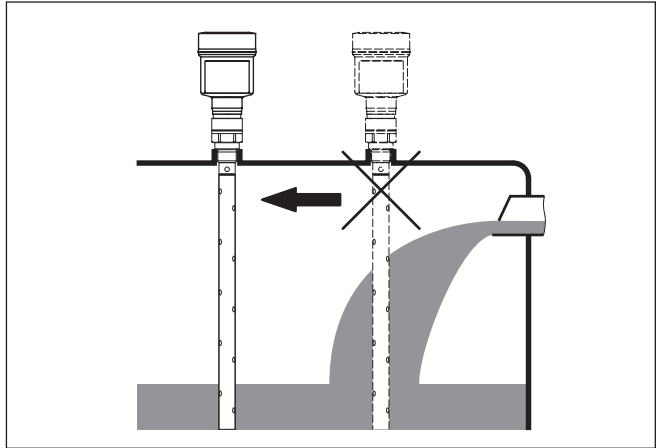

Fig. 5: Mounting of the sensor with inflowing medium

Measuring range

The reference plane for the measuring range of the sensors is the sealing surface of the thread or flange.

Keep in mind that a min. distance must be maintained below the reference plane and possibly also at the end of the probe - measurement in these areas is not possible (dead zone). These dead zones are listed in chapter "*Technical data*". Keep in mind for the adjustment that the default setting for the measuring range refers to water.

Pressure

The process fitting must be sealed if there is gauge or low pressure in the vessel. Before use, check if the seal material is resistant against the measured product and the process temperature.

The max. permissible pressure is specified in chapter "*Technical data*" or on the type label of the sensor.

Fasten

If there is a risk of the coaxial probe touching the vessel wall during operation due to product movements or agitators, etc., the measuring probe should be securely fixed.

Avoid undefined vessel connections, i.e. the connection must be either grounded reliably or isolated reliably. Any undefined change of this condition can lead to measurement errors.

If there is a danger of the coaxial probe touching the vessel wall, then the probe must be fastened at the bottom end.

Keep in mind that measurement is not possible below the fastening point.

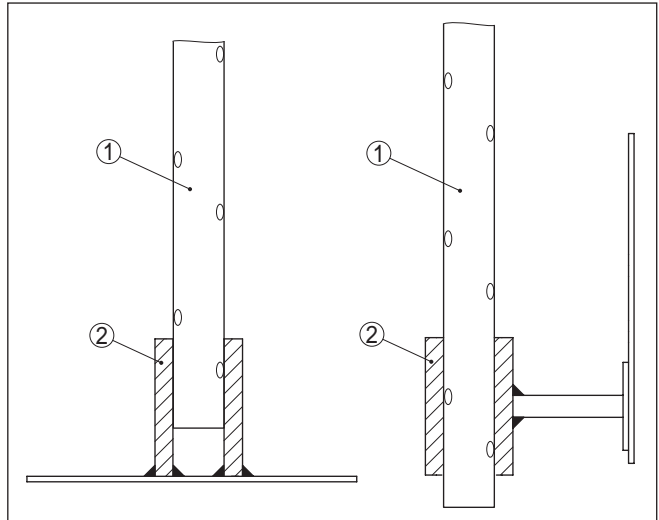

Fig. 6: Fasten the probe

- 1 Coax probe
- 2 Retaining sleeve

5 Connecting to power supply

5.1 Preparing the connection

Safety instructions

Always keep in mind the following safety instructions:

- Carry out electrical connection by trained, qualified personnel authorised by the plant operator
- If overvoltage surges are expected, overvoltage arresters should be installed



Warning:

Only connect or disconnect in de-energized state.

Voltage supply

Power supply and current signal are carried on the same two-wire cable. The operating voltage can differ depending on the instrument version.

The data for power supply are specified in chapter "*Technical data*".

Provide a reliable separation between the supply circuit and the mains circuits according to DIN EN 61140 VDE 0140-1.

Power the instrument via an energy-limited circuit acc. to IEC 61010-1, e.g. via Class 2 power supply unit.

Keep in mind the following additional factors that influence the operating voltage:

- Lower output voltage of the power supply unit under nominal load (e.g. with a sensor current of 20.5 mA or 22 mA in case of fault)
- Influence of additional instruments in the circuit (see load values in chapter "*Technical data*")

Connection cable

The instrument is connected with standard two-wire cable without screen. If electromagnetic interference is expected which is above the test values of EN 61326-1 for industrial areas, screened cable should be used.

Use cable with round cross section for instruments with housing and cable gland. Use a cable gland suitable for the cable diameter to ensure the seal effect of the cable gland (IP protection rating).

Cable glands

Metric threads

In the case of instrument housings with metric thread, the cable glands are screwed in at the factory. They are sealed with plastic plugs as transport protection.



Note:

You have to remove these plugs before electrical connection.

NPT thread

In the case of instrument housings with self-sealing NPT threads, it is not possible to have the cable entries screwed in at the factory. The free openings for the cable glands are therefore covered with red dust protection caps as transport protection.

Note:

Prior to setup you have to replace these protective caps with approved cable glands or close the openings with suitable blind plugs.

On plastic housings, the NPT cable gland or the Conduit steel tube must be screwed into the threaded insert without grease.

Max. torque for all housings, see chapter "*Technical data*".

Cable screening and grounding

If screened cable is required, we recommend connecting the cable screening on both ends to ground potential. In the sensor, the cable screening must be connected directly to the internal ground terminal. The ground terminal on the outside of the housing must be connected to the ground potential (low impedance).



In Ex systems, the grounding is carried out according to the installation regulations.

In electroplating plants as well as plants for cathodic corrosion protection it must be taken into account that significant potential differences exist. This can lead to unacceptably high currents in the cable screen if it is grounded at both ends.

Information:

The metallic parts of the instrument (process fitting, sensor, concentric tube, etc.) are connected with the internal and external ground terminal on the housing. This connection exists either directly via the conductive metallic parts or, in case of instruments with external electronics, via the screen of the special connection cable.

You can find specifications on the potential connections inside the instrument in chapter "*Technical data*".

5.2 Connecting

Connection technology

The voltage supply and signal output are connected via the spring-loaded terminals in the housing.

Connection to the display and adjustment module or to the interface adapter is carried out via contact pins in the housing.

Information:

The terminal block is pluggable and can be removed from the electronics. To do this, lift the terminal block with a small screwdriver and pull it out. When reinserting the terminal block, you should hear it snap in.

Connection procedure

Proceed as follows:

1. Unscrew the housing lid
2. If a display and adjustment module is installed, remove it by turning it slightly to the left
3. Loosen compression nut of the cable gland and remove blind plug
4. Remove approx. 10 cm (4 in) of the cable mantle, strip approx. 1 cm (0.4 in) of insulation from the ends of the individual wires
5. Insert the cable into the sensor through the cable entry

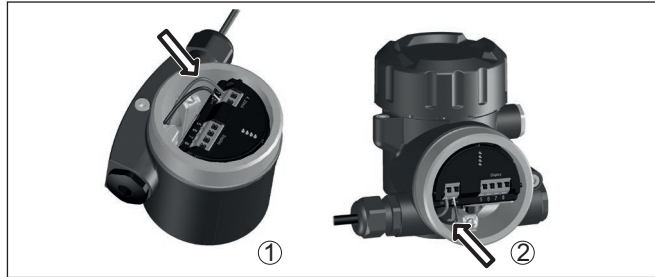

Fig. 7: Connection steps 5 and 6

- 1 Single chamber housing
- 2 Double chamber housing

6. Insert the wire ends into the terminals according to the wiring plan



Information:

Solid cores as well as flexible cores with wire end sleeves are inserted directly into the terminal openings. In case of flexible cores without end sleeves, press the terminal from above with a small screwdriver, the terminal opening is then free. When the screwdriver is released, the terminal closes again.

You can find further information on the max. wire cross-section under "*Technical data - Electromechanical data*".

7. Check the hold of the wires in the terminals by lightly pulling on them
8. Connect the screen to the internal ground terminal, connect the external ground terminal to potential equalisation
9. Tighten the compression nut of the cable entry gland. The seal ring must completely encircle the cable
10. Reinsert the display and adjustment module, if one was installed
11. Screw the housing lid back on

The electrical connection is finished.

5.3 Wiring plan, single chamber housing



The following illustration applies to the non-Ex, Ex-ia and Ex-d-ia version.

Electronics and connection compartment

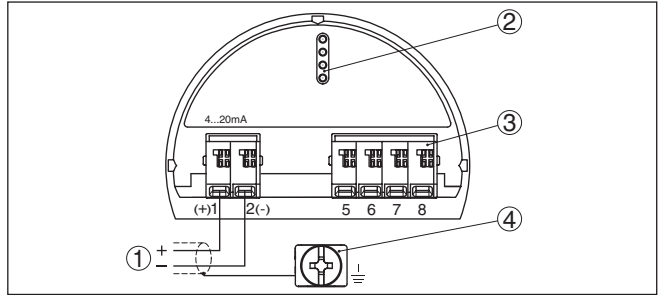

Fig. 8: Electronics and connection compartment - single chamber housing

- 1 Voltage supply, signal output
- 2 For display and adjustment module or interface adapter
- 3 For external display and adjustment unit
- 4 Ground terminal for connection of the cable screening

5.4 Wiring plan, double chamber housing



The following illustrations apply to the non-Ex as well as to the Ex-ia version.

Electronics compartment

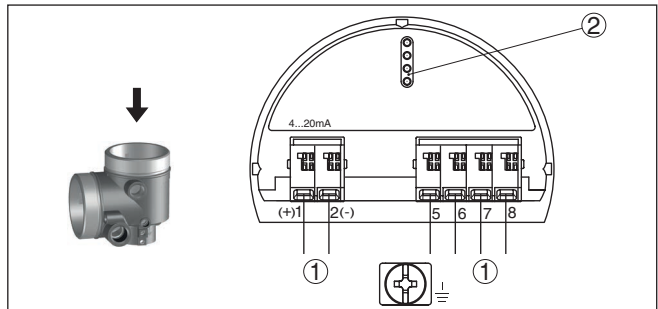

Fig. 9: Electronics compartment - double chamber housing

- 1 Internal connection to the connection compartment
- 2 For display and adjustment module or interface adapter

Connection compartment

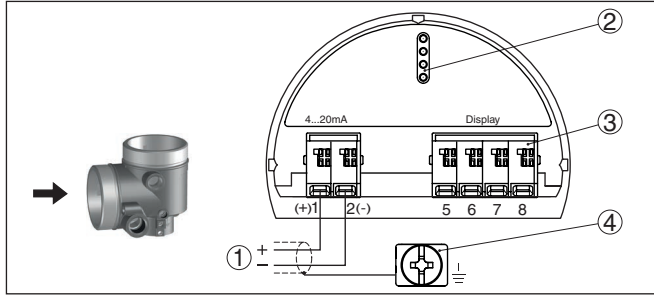

Fig. 10: Connection compartment - double chamber housing

- 1 Voltage supply, signal output
- 2 For display and adjustment module or interface adapter
- 3 For external display and adjustment unit
- 4 Ground terminal for connection of the cable screening

6 Functional safety (SIL)

6.1 Objective



In case of dangerous failures, processing facilities and machines can cause risks for persons, environment and property. The risk of such failures must be judged by the plant operator. Dependent thereon are measures for risk reduction through error prevention, error detection and fault control.

The part of plant safety depending on the correct functioning of safety-related components for risk reduction is called functional safety. Components used in such safety-instrumented systems (SIS) must therefore execute their intended function (safety function) with a defined high probability.

The safety requirements for such components are described in the international standards IEC 61508 and 61511, which set the standard for uniform and comparable judgement of instrument and plant (or machine) safety and hence contribute to worldwide legal certainty. We distinguish between four safety levels, from SIL1 for low risk to SIL4 for very high risk (SIL = Safety Integrity Level), depending on the required degree of risk reduction.

6.2 SIL qualification

Additional characteristics and requirements

When developing instruments that can be used in safety-instrumented systems, the focus is on avoiding systematic errors as well as determining and controlling random errors.

Here are the most important characteristics and requirements from the perspective of functional safety according to IEC 61508 (Edition 2):

- Internal monitoring of safety-relevant circuit parts
- Extended standardization of the software development
- In case of failure, switching of the safety-relevant outputs to a defined safe state
- Determination of the failure probability of the defined safety function
- Reliable parameterization with non-safe user environment
- Proof test

The SIL qualification of components is specified in a manual for functional safety (Safety Manual). Here, you can find all safety-relevant characteristics and information required by the user and planner for planning and operating the safety-relevant system. This document is attached to each instrument with SIL rating and can be also retrieved on our homepage.

6.3 Application area

The instrument can be used for point level detection or level measurement of liquids and bulk solids in safety-instrumented systems (SIS) according to IEC 61508 and IEC 61511. Take note of the specifications in the Safety Manual.

The following inputs/outputs are permitted:

- 4 ... 20 mA current output

6.4 Safety concept of the parameterization

Tool for operation and parameterization

The following tools are permitted for parameterization of the safety function:

- The integrated display and adjustment unit for on-site adjustment
- The DTM suitable for the controller in conjunction with an adjustment software according to the FDT/DTM standard, e. g. PACTware



Note:

The change of safety-relevant parameters is only possible with active connection to the instrument (online mode)

Safe parameterization

To avoid possible errors during parameterisation in a non-safe operating environment, a verification procedure is used that enables reliable detection of parameter adjustment errors. The safety-relevant parameters have to be verified after they are saved in the instrument. In normal operating condition, the instrument is also protected (locked) against inadvertent or unauthorized parameter changes. This concept applies to adjustment directly on the instrument as well as adjustment with PACTware and DTM.

Safety-relevant parameters

To prevent unintentional or unauthorized adjustment, the set parameters must be protected from unauthorized access. For this reason the instrument is shipped in locked condition. The PIN in delivery status is "0000".

When shipped with a specific parameter adjustment, the instruments are accompanied by a list with the values deviating from the basic setting.

All safety-relevant parameters must be verified after a change.

The parameter settings of the measurement loop must be documented. You can find a list of all safety-relevant parameters in the delivery status in chapter "*Setup with the display and adjustment module*" under "*Additional adjustments - Reset*". In addition, a list of the safety-relevant parameters can be stored and printed via PACTware/DTM.

Unlock adjustment

For each parameter change, the instrument must be unlocked via a PIN (see chapter "*Setup steps - Lock adjustment*"). The device status is indicated by the symbol of an unlocked or locked padlock.



In delivery status, the PIN is **0000**.

Unsafe device status



Warning:

If adjustment is enabled, the safety function must be considered as unreliable. This applies until the parameterisation is terminated correctly. If necessary, other measures must be taken to maintain the safety function.

Change parameters		All parameters changed by the operator are automatically stored temporarily so that they can be verified in the next step.
Verify parameters/Lock adjustment		<p>After setup, the modified parameters must be verified (confirm the correctness of the parameters). To do this, you first have to enter the PIN. Here the adjustment is locked automatically. Then you carry out a comparison of two character strings. You must confirm that the character strings are identical. This is used to check the character presentation.</p> <p>Then you confirm that the serial number of your instrument has been carried over correctly. This is used to check device communication.</p> <p>Then, all modified parameters that have to be confirmed are listed. After this process is terminated, the safety function is again ensured.</p>
Incomplete process		<p>Warning: If the described process was not carried out completely or correctly (e.g. due to interruption or voltage loss), the instrument remains in an unlocked, and thus unsafe, status.</p>
Instrument reset		<p>Warning: In case of a reset to basic settings, all safety-relevant parameters will also be reset to default. Therefore all safety-relevant parameters must be checked or readjusted.</p>
 6.5 Setup process 		
Operating sequence		
A parameter change with SIL qualified instruments must always be carried out as follows.		
<ul style="list-style-type: none"> ● Unlock adjustment ● Change parameters ● Lock adjustment and verify modified parameters 		
Start: Safe operating state		<p>The setup must be carried out according to an exactly specified pattern.</p> <p>Generally the instrument is in safe operating state before the adjustment is released.</p>
Unlock adjustment		<p>Each parameter change requires the release of the instrument through a PIN (see chapter "<i>Setup steps - Lock adjustment</i>").</p> <p>In delivery status, the PIN is 0000.</p>
Change parameters		Set up the NivoGuide 8100 according to the specification in this operating instructions and the Safety Manual.
Setup - Function test		When locking the adjustment, the instrument checks the data of the measurement loop and decides on the basis of the evaluation results if a function test is required.

Function test not required

If the parameter check was successful, the adjustment is locked automatically and the instrument is again in safe operating state.

Setup is then finished.

Function test required

Should a function test be necessary, the following message is displayed on the display and adjustment module. The adjustment software also signals that a function test is required.

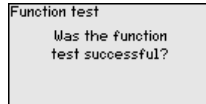

If a function test is required, the switching point or the range must be controlled with the original medium. For this purpose, you have to decide for your application which condition is potentially critical.

Function test

During a function test, you have to test the safety function of the instrument in the vessel with the original medium.

For this purpose, you should know the filling height of the vessel as well as the min. and max. levels respectively for 4 and 20 mA. You then can calculate the respective output current.

Measure the output current of NivoGuide 8100 with a suitable multi-meter and compare the measured output current with the calculated output current.



If you have to interrupt the function, you can leave the NivoGuide 8100 in the respective situation.

As long as NivoGuide 8100 is powered, the display and adjustment module remains in the currently set adjustment menu.

To interrupt the function test, you have to push the button "ESC".

If you carry out the function test by means of the "PACTware" software, you can store the previously performed tests and continue from there later on.

If you click to "Complete", the adjustment of the instrument is locked, but not yet verified. After conclusion of the function test, you have to restart the adjustment.

If a function test is necessary, please proceed as follows:

Mode overflow protection/dry run protection

Select the respective safety function (overflow protection/dry run protection) for your application.

1. Raise the level to directly below the switching point
Keep a holding time of 1 minute for each level before you compare the measured value.
2. Lower the level to directly above the switching point
Keep a holding time of 1 minute for each level before you compare the measured value.

Result

In both cases the output current must correspond to the respective level.

Measure the current output and compare the value with the calculated current value.

You have to determine the permissible deviation of the values yourself. This deviation depends on the the accuracy requirements of your measurement loop. Determine the permissible tolerance for the deviation.

Mode "Range monitoring"

If both levels are important for the safety function, you have to proceed according to the mode "Range monitoring".

1. Move the level to at least three points within the range limits.
Keep a holding time of 1 minute for each level before you compare the measured value.
2. Move the level to a point directly above and directly below the range limits.
Keep a holding time of 1 minute for each level before you compare the measured value.

Result

In all cases the output current must correspond to the respective level.

For this purpose, you have to measure for all levels the current output and compare the values with the calculated current values.

You have to determine the permissible deviation of the values yourself. This deviation depends on the the accuracy requirements of your measurement loop. Determine the permissible tolerance for the deviation.

Verify parameters/Lock adjustment

After setup, the modified parameters must be verified. To do this, you first have to enter the current PIN. The adjustment is then locked automatically. Then you carry out a comparison of two character strings. You must confirm that the character strings are identical. This is used to check the character presentation.

Then you confirm that the serial number of your instrument has been carried over correctly. This is used to check device communication.

Then, all modified parameters that have to be confirmed are listed. After this process is terminated, the safety function is again ensured.

7 Set up with the display and adjustment module

7.1 Insert display and adjustment module

The display and adjustment module can be inserted into the sensor and removed again at any time. You can choose any one of four different positions - each displaced by 90°. It is not necessary to interrupt the power supply.

Proceed as follows:

1. Unscrew the housing lid
2. Place the display and adjustment module on the electronics in the desired position and turn it to the right until it snaps in.
3. Screw housing lid with inspection window tightly back on

Disassembly is carried out in reverse order.

The display and adjustment module is powered by the sensor, an additional connection is not necessary.



Fig. 11: Installing the display and adjustment module in the electronics compartment of the single chamber housing



Fig. 12: Installing the display and adjustment module in the double chamber housing

- 1 In the electronics compartment
- 2 In the connection compartment



Note:

If you intend to retrofit the instrument with a display and adjustment module for continuous measured value indication, a higher lid with an inspection glass is required.

7.2 Adjustment system

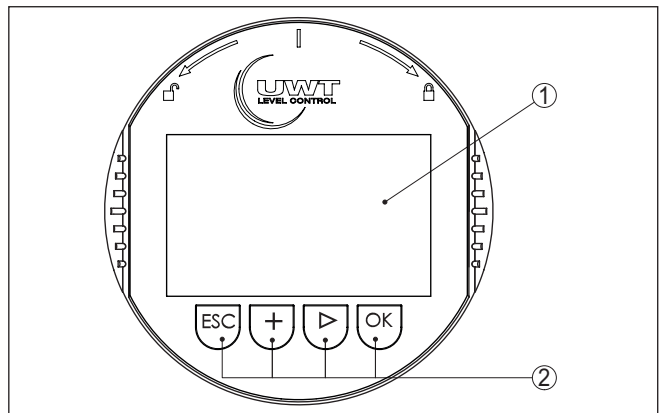

Fig. 13: Display and adjustment elements

- 1 LC display
- 2 Adjustment keys

- [OK] key:

- Move to the menu overview
- Confirm selected menu
- Edit parameter
- Save value
- **[->]** key:
 - Change measured value presentation
 - Select list entry
 - Select editing position
- **[+]** key:
 - Change value of the parameter
- **[ESC]** key:
 - Interrupt input
 - Jump to next higher menu

Adjustment system

The sensor is operated via the four keys of the display and adjustment module. The individual menu items are shown on the LC display. You can find the function of the individual keys in the previous illustration.

When the **[+]** and **[->]** keys are pressed quickly, the edited value, or the cursor, changes one value or position at a time. If the key is pressed longer than 1 s, the value or position changes continuously.

When the **[OK]** and **[ESC]** keys are pressed simultaneously for more than 5 s, the display returns to the main menu. The menu language is then switched over to "English".

Approx. 60 minutes after the last pressing of a key, an automatic reset to measured value indication is triggered. Any values not confirmed with **[OK]** will not be saved.

Switch-on phase

After switching on, the NivoGuide 8100 carries out a short self-test where the device software is checked.

The output signal transmits a fault signal during the switch-on phase.

The following information is displayed on the display and adjustment module during the startup procedure:

- Instrument type
- Device name
- Software version (SW-Ver)
- Hardware version (HW-Ver)

Measured value indication

With the **[->]** key you can move between three different indication modes.

In the first view, the selected measured value is displayed in large digits.

In the second view, the selected measured value and a corresponding bar graph presentation are displayed.

In the third view, the selected measured value as well as a second selectable value, e.g. the temperature, are displayed.



7.3 Parameter adjustment - Extended adjustment

For technically demanding measuring points, you can carry out extended settings in "Extended adjustment".

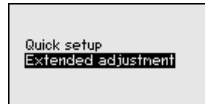

Main menu

The main menu is divided into five sections with the following functions:

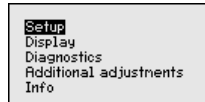

Setup: Settings, e.g. measurement loop name, medium, vessel, adjustment, signal output, device unit, false signal suppression, linearization curve

Display: Settings, e.g., for language, measured value display, lighting

Diagnosis: Information, e.g. on instrument status, pointer, measurement reliability, simulation, echo curve

Additional adjustments: Reset, date/time, reset, copy function

Info: Instrument name, hardware and software version, date of manufacture, instrument features



Note:

For optimum adjustment of the measuring point, the individual submenu items in the main menu item "Setup" should be selected one after the other and provided with the correct parameters. If possible, go through the items in the given sequence.

The procedure is described below.

The following submenu points are available:

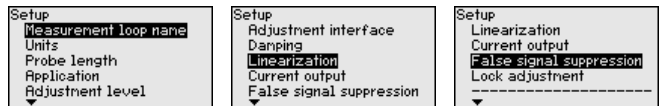

The submenu points are described below.

7.3.1 Setup

Measurement loop name

Here you can assign a suitable measurement loop name. Push the "OK" key to start the editing. With the "+" key you change the sign and with the ">" key you jump to the next position.

You can enter names with max. 19 characters. The character set comprises:

- Capital letters from A ... Z
- Numbers from 0 ... 9
- Special characters + - / _ blanks

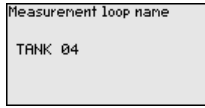

Units

In this menu item you select the distance unit and the temperature unit.

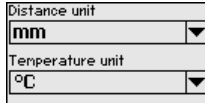

For the distance units you can choose between m, mm and ft and for the temperature units °C, °F and K.

Probe length

In this menu item you can enter the probe length or have the length determined automatically by the sensor system.

When choosing "Yes", then the probe length will be determined automatically. When choosing "No", you can enter the probe length manually.

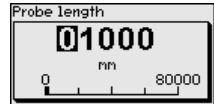
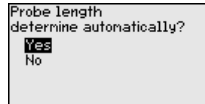
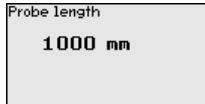

Application - Medium type

Coax probes can be only used in liquids. In this menu item, the fixed adjusted medium type "Liquid" is displayed.

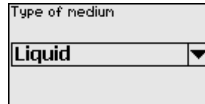
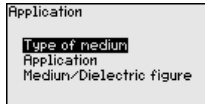

Application - Application

In this menu item, you can select the application. You can choose between level measurement and interface measurement. You can also choose between measurement in a vessel or in a bypass or standpipe.



Note:

The selection of the application has a considerable influence on all other menu items. Keep in mind that as you continue with the parameter adjustment, individual menu items are only optionally available.

You have the option of choosing the demonstration mode. In this mode, the sensor ignores the parameters of the application and reacts immediately to any change.



This mode is only suitable for test and demonstration purposes and must not be used in a safety-instrumented application (SIL).

Application - Medium, dielectric constant

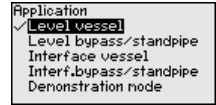
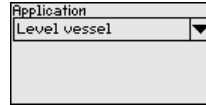
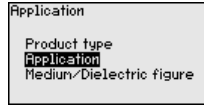

In this menu item, you can define the type of medium (product).

This menu item is only available if you have selected level measurement under the menu item "Application".

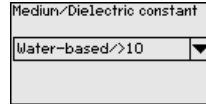
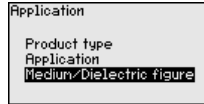

You can choose between the following medium types:

Dielectric constant	Type of medium	Examples
> 10	Water-based liquids	Acids, alcalis, water
3 ... 10	Chemical mixtures	Chlorobenzene, nitro lacquer, aniline, isocyanate, chloroform
< 3	Hydrocarbons	Solvents, oils, liquid gas

Application - Gas phase

This menu item is only available, if you have chosen interface measurement under the menu item "Application". In this menu item you can enter if there is a superimposed gas phase in your application.

Only set the function to "Yes", if the gas phase is permanently present.

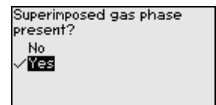
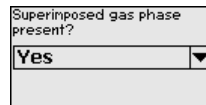
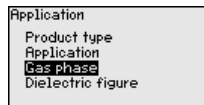

Application - Dielectric constant

This menu item is only available if you have selected interface measurement under the menu item "Application". In this menu item you can enter the dielectric constant of the upper medium.

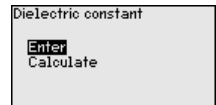
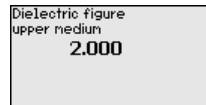
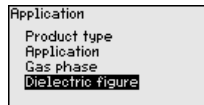

You can directly enter the dielectric constant of the upper medium or have the value determined by the instrument.

If you want the dielectric constant to be determined by the instrument, you have to enter the measured or known distance to the interface.

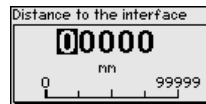
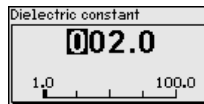

Max. adjustment level

In this menu item you can enter the max. adjustment for the level. With interface measurement this is the maximum total level.

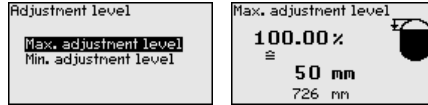

Adjust the requested percentage value with **[+]** and store with **[OK]**.

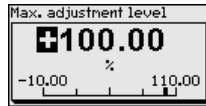

Enter the appropriate distance value in m (corresponding to the percentage value) for the full vessel. The distance refers to the sensor reference plane (seal surface of the process fitting). Keep in mind that the max. level must lie below the dead zone.

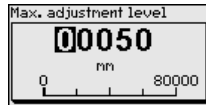

Min. adjustment level

In this menu item you can enter the min. adjustment for the level. With interface measurement this is the minimum total level.

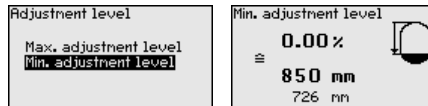

Adjust the requested percentage value with **[+]** and store with **[OK]**.

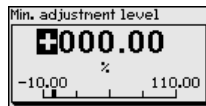

Enter the suitable distance value in m for the empty vessel (e.g. distance from the flange to the probe end) corresponding to the percentage value. The distance refers to the sensor reference plane (seal surface of the process fitting).

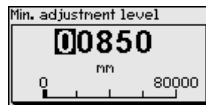

Max. adjustment interface

This menu item is only available if you have selected interface measurement under the menu item "Application".

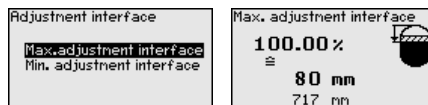

Enter the requested percentage value for the max. adjustment.

As an alternative, you have the possibility taking over the adjustment of the level measurement also for the interface.

Enter the respective distance value in m for the surface of the upper medium corresponding to the percentage value.

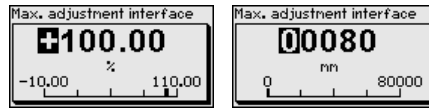

Min. adjustment interface This menu item is only available if you have selected interface measurement under the menu item "Application".



Enter the requested percentage value for the min. adjustment (interface).

Enter the respective distance value in m for the interface corresponding to the percentage value of the interface.

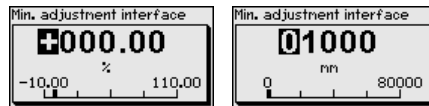

Damping

To damp process-dependent measured value fluctuations, set an integration time of 0 ... 999 s in this menu item.

If you have selected interface measurement under the menu item "Application", you can adjust the damping for the level and the interface separately.

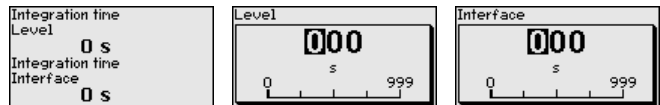

The default setting is a damping of 0 s.

Linearisation

A linearisation is necessary for all vessels in which the vessel volume does not increase linearly with the level - e.g. a horizontal cylindrical or spherical tank, when the indication or output of the volume is required. Corresponding linearisation curves are preprogrammed for these vessels. They represent the correlation between the level percentage and vessel volume.

The linearisation applies to the measured value indication and the current output. By activating the appropriate curve, the volume percentage of the vessel is displayed correctly. If the volume should not be displayed in percent but e.g. in l or kg, a scaling can be also set in the menu item "Display".

7 Set up with the display and adjustment module

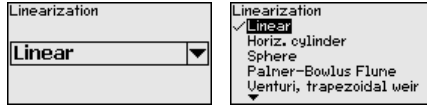

Warning:

If a linearisation curve is selected, the measuring signal is no longer necessarily linear to the filling height. This must be considered by the user especially when setting the switching point on the limit signal transmitter.

In the following, you have to enter the values for your vessel, for example the vessel height and the socket correction.

For non-linear vessel forms, enter the vessel height and the socket correction.

For the vessel height, you have to enter the total height of the vessel.

For the socket correction you have to enter the height of the socket above the upper edge of the vessel. If the socket is lower than the upper edge of the vessel, this value can also be negative.

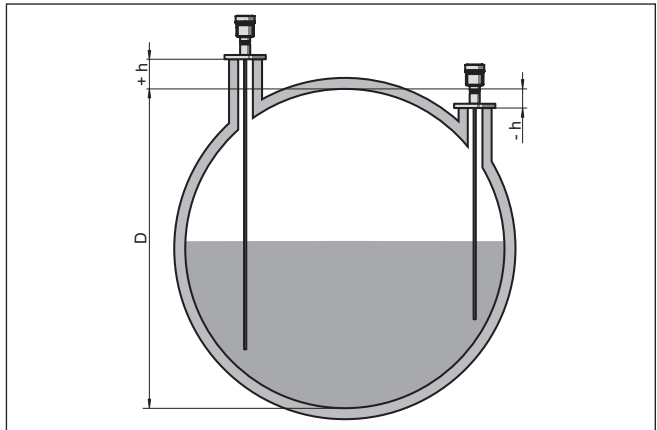
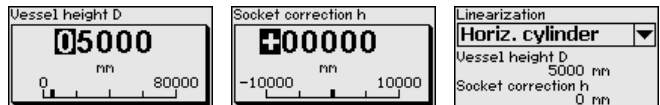

Fig. 14: Vessel height and socket correction value

D Vessel height

+h Positive socket correction value

-h Negative socket correction value



Current output mode

In the menu item "Current output mode" you determine the output characteristics and reaction of the current output in case of fault.

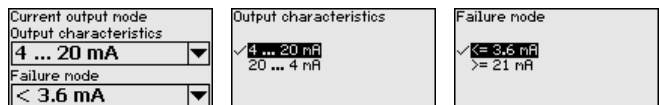

The default setting is output characteristics 4 ... 20 mA, fault mode < 3.6 mA.

Current output, min./max. In the menu item "*Current output Min./Max.*", you determine the reaction of the current output during operation.



The default setting is min. current 3.8 mA and max. current 20.5 mA.

False signal suppression The following circumstances cause interfering reflections and can influence the measurement:

- High mounting sockets
- Vessel internals such as struts



Note:

A false signal suppression detects, marks and saves these false signals so that they are no longer taken into account for the level and interface measurement. We generally recommend carrying out a false signal suppression to achieve the best possible accuracy. This should be done with the lowest possible level so that all potential interfering reflections can be detected.

Proceed as follows:

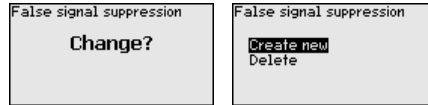

Select first if the probe is covered or uncovered.

If the probe is covered, enter the actual distance from the sensor to the product surface.

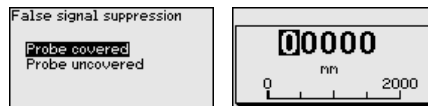

All interfering signals in this section are detected by the sensor and stored.

Keep in mind that with covered probe only false signals in the uncovered area of the probe are detected.



Note:

Check the distance to the product surface, because if an incorrect (too large) value is entered, the existing level will be saved as a false signal. The level would then no longer be detectable in this area.

If a false signal suppression has already been created in the sensor, the following menu window appears when selecting "*False signal suppression*":



The instrument carries out an automatic false signal suppression as soon as the probe is uncovered. The false signal suppression is always updated.

The menu item "Delete" is used to completely delete an already created false signal suppression. This is useful if the saved false signal suppression no longer matches the metrological conditions in the vessel.

Unlock adjustment

With this menu item you safeguard the sensor parameters against unauthorized or unintentional modifications.

To avoid possible errors during parameterization in a non-safe user environment, a verification procedure is used that makes it possible to detect parameterization errors reliably. For this, safety-relevant parameters must be verified before they are stored in the device. In normal operating condition, the instrument is also locked against parameter changes through unauthorized access.

For this reason, the instrument is shipped in locked condition. The PIN in the delivery status is **0000**.

Call our service department if you have modified and forgotten the PIN.

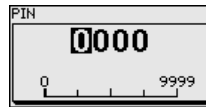

Character string comparison and serial number

You first have to carry out the character string comparison. This is used to check the character representation.

Confirm if the two character strings are identical. The verification texts are provided in German and in the case of all other menu languages, in English.

Afterwards you confirm that the serial number of your instrument was carried over correctly. This is used to check device communication.

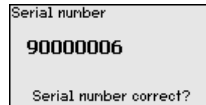
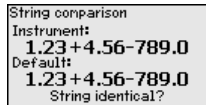

In the next step, the instrument checks the data of the measurement and decides by means of the evaluation results if a functions test is required. If a function test is necessary, the following message is displayed.

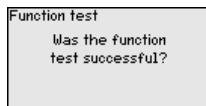

In this case, you have to carry out a function test.

Function test

During a function test, you have to test the safety function of the instrument in the vessel with the original medium.

SIL You can find the detailed sequence of the function test in chapter "Functional safety (SIL)"

For this purpose, you should know the filling height of the vessel as well as the min. and max. levels respectively for 4 and 20 mA. You then can calculate the respective output current.

Measure the output current of NivoGuide 8100 with a suitable multi-meter and compare the measured output current with the calculated output current.

You have to determine the permissible deviation of the values yourself. This deviation depends on the the accuracy requirements of your measurement loop. Determine the permissible tolerance for the deviation.

SIL If you have to interrupt the function, you can leave the NivoGuide 8100 in the respective situation.

As long as NivoGuide 8100 is powered, the display and adjustment module remains in the currently set adjustment menu.

To interrupt the function test, you have to push the button "ESC".

If you carry out the function test by means of the "PACTware" software, you can store the previously performed tests and continue from there later on.

Verify parameter

All safety-relevant parameters must be verified after a change. After the function test, all modified, safety-relevant parameters will be listed. Confirm the modified values one after the other.

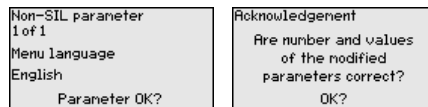

If the described process of parameter adjustment was run through completely and correctly, the instrument will be locked and hence ready for operation.



Otherwise the instrument remains in the released and hence unsafe condition.

SIL If you have to interrupt the function test, you can leave the display and adjustment module of NivoGuide 8100 in its current state.

As long as NivoGuide 8100 is powered, the display and adjustment module remains in the currently set adjustment menu.

To interrupt the function test, you have to push the button "ESC".

If you carry out the function test by means of the "PACTware" software, you can store the previously performed tests and continue from there later on.

Current output 2

If a supplementary electronics with an additional current output is installed in the instrument, you can adjust the additional current output separately.

In menu item "Current output 2" you specify which measured value the additional current output refers to.



The additional current output cannot be used as an output in the sense of a safety-instrumented application (SIL).

The procedure corresponds to the previous settings of the standard current output. See "Setup - Current output".

7.3.2 Display

Display

In the main menu point "Display", the individual submenu points should be selected one after the other and provided with the correct parameters to ensure the optimum adjustment of the display options. The procedure is described in the following.

The following submenu points are available:

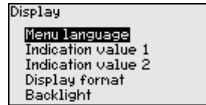

The submenu points are described below.

Menu language

This menu item enables the setting of the requested national language.

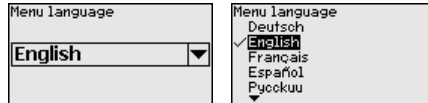

In delivery status, the sensor is set to English.

Displayed value 1

In this menu item, you define the indication of the measured value on the display. You can display two different measured values. In this menu item, you define measured value 1.

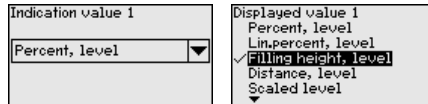

The default setting for the displayed value 1 is "Filling height Level".

Displayed value 2

In this menu item, you define the indication of the measured value on the display. You can display two different measured values. In this menu item, you define measured value 2.

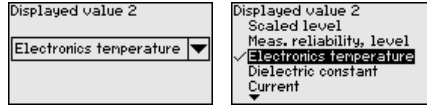

The default setting for the displayed value 2 is the electronics temperature.

Display format

In this menu item, you define the display format of the measured value on the display. You can define different display formats for the two measured values.

You can thus define the number of decimal positions the measured value is displayed with.

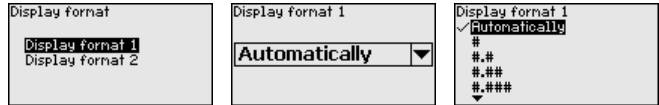

The default setting for the display format is "Automatic".

Backlight

The integrated background lighting can be switched off via the adjustment menu. The function depends on the strength of the supply voltage, see "Technical data".

To maintain the function of the device, the lighting is temporarily switched off if the power supply is insufficient.



In delivery status, the lighting is switched on.

7.3.3 Diagnostics

Sensor status

In this menu item, the device status is displayed.

When the instrument displays a failure message, you can here get detailed information on the failure reason.

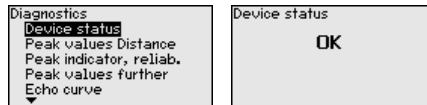

Peak values, distance

The respective min. and max. measured value is saved in the sensor. The two values are displayed in the menu item "Peak values, distance".

If you have selected interface measurement under the menu item "Setup - Application", the peak values of the interface measurement are displayed in addition to the peak values of the level measurement.

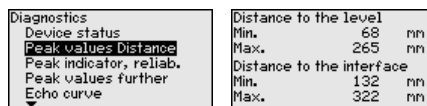

In another window you can carry out a reset of the two peak values separately.

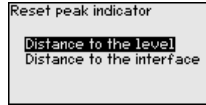

Peak values, measurement reliability

The respective min. and max. measured values are saved in the sensor. The two values are displayed in the menu item "Peak values, measurement reliability".

The measurement can be influenced by the process conditions. In this menu item, the measurement reliability of the level measurement is displayed in mV. The higher the value, the more reliable the measurement.

If you have selected interface measurement under the menu item "Setup - Application", the peak values of the interface measurement are displayed in addition to the peak values of the level measurement.

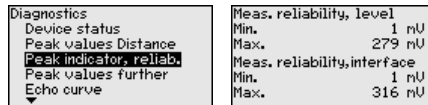

In another window you can carry out a reset of the two peak values separately.

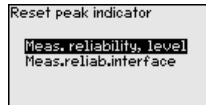

Peak values, additional

The respective min. and max. measured values are saved in the sensor. The values are displayed in the menu item "Peak values Additional".

This menu item displays the peak values of the electronics temperature as well as the dielectric constant.

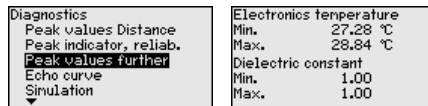

In another window you can carry out a reset of the two peak values separately.

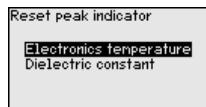

Information:

If one of the display values flashes, there is actually no valid value available.

Echo curve

The menu item "Echo curve" shows the signal strength of the echoes over the measuring range in V. The signal strength enables an evaluation of the quality of the measurement.

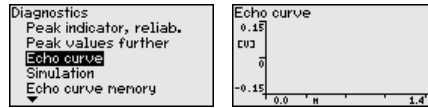

With the following functions you can zoom part sections of the echo curve.

- "X-Zoom": Zoom function for the meas. distance
- "Y-Zoom": 1, 2, 5 and 10x signal magnification in "V"
- "Unzoom": Reset the presentation to the nominal measuring range without magnification

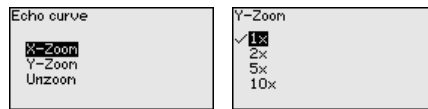

Simulation

In this menu item you can simulate measured values via the current output. This allows the signal path to be tested, e.g. through downstream indicating instruments or the input card of the control system.

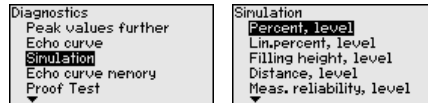

Select the requested simulation variable and set the requested value.

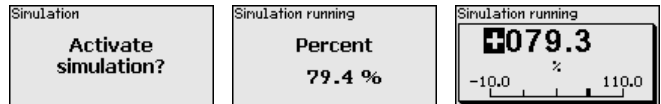

Caution:

During simulation, the simulated value is output as 4 ... 20 mA current value and digital HART signal.

Push the **[ESC]** key to deactivate the simulation.



Information:

The simulation is terminated automatically 60 minutes after the activation of the simulation.

Echo curve memory

With the menu item "Setup" the echo curve it is possible to save at the time of setup. This is generally recommended; for using the Asset Management functions it is necessary. If possible, the curve should be saved with a low level in the vessel.

With this, you can detect signal changes over the operating time. With the adjustment software PACTware and the PC, the high-resolution echo curve can be displayed and used to compare the echo curve of the setup with the actual echo curve.

7 Set up with the display and adjustment module

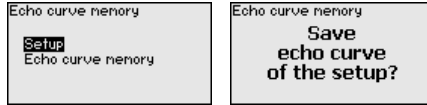

The function "Echo curve memory" enables storing echo curves of the measurement.

Under the sub-menu item "Echo curve memory" you can store the current echo curve.

Parameter settings for recording the echo curve and the settings of the echo curve itself can be carried out in the adjustment software PACTware.

With the adjustment software PACTware and the PC the high-resolution echo curve can be displayed and used later on to assess the quality of the measurement.

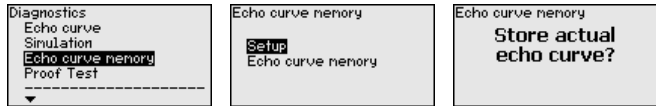

Proof test

With the function "Proof test", the function of the instrument can be checked on a recurring basis.



During the function test, the safety function must be treated as unsafe. Keep in mind that the function test influences downstream connected devices.

You can find detailed information on the proof test in the Safety Manual (SIL).

7.3.4 Additional adjustments

Date/Time

In this menu item, the internal clock of the sensor is set.

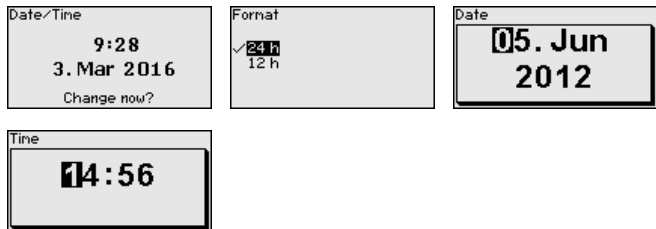

Reset

After a reset, certain parameter adjustments made by the user are reset.



Note:

After this menu window, the reset process is carried out. No further safety inquiry follows.

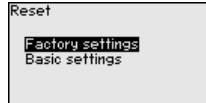

The following reset functions are available:

Delivery status: Restores the parameter settings at the time of shipment from the factory, incl. order-specific settings. Any stored false signal suppression or user-programmed linearisation curve, as well as the measured value memory, are deleted.

Basic settings: Resetting of the parameter settings incl. special parameters to the default values (presettings) of the respective instrument. Any created false signal suppression or user-programmable linearization curve as well as the measured value memory are deleted.

The following tables show the default values of the instrument. Depending on the instrument version or application, all menu items may not be available or some may be differently assigned.

The menu items in bold are safety-relevant in terms of the functional safety according to IEC 61508 (Edition 2) SIL.

Menu - Setup

Menu item	Default value
Lock adjustment	Locked
Measurement loop name	Sensor
Units	Distance unit: order-specific Temperature unit: order-specific
Probe length	Länge der Messsonde factory setting
Type of medium	Liquid
Application	Level, vessel
Medium, dielectric constant	Water-based, > 10
Superimposed gas phase	Yes
Dielectric constant, upper medium (TS)	1.5
Tube inner diameter	200 mm
Max. adjustment - Level	100 %
Max. adjustment - Level	Distance: 0.000 m(d) - Note dead zones
Min. adjustment - Level	0 %
Min. adjustment - Level	Distance: Probe length - Note dead zones
Accept adjustment of the level measurement?	No
Max. adjustment - Interface	100 %
Max. adjustment - Interface	Distance: 0.000 m(d) - Note dead zones
Min. adjustment - Interface	0 %
Min. adjustment - Interface	Distance: Probe length - Note dead zones
Integration time - Level	0.0 s

7 Set up with the display and adjustment module

Menu item	Default value
Integration time - Interface	0.0 s
Linearisation type	Linear
Linearisation - Socket correction	0 mm
Linearisation - Vessel height	Probe length
Scaling variable - Level	Volume in l
Scaling unit - Level	Litres
Scaling format - Level	Without decimal positions
Scaling level - 100 % corresponds to	100
Scaling level - 0 % corresponds to	0
Accept scaling of the level measurement	Yes
Scaling variable - Interface	Volume
Scaling unit - Interface	Litres
Scaling format - Interface	Without decimal positions
Scaling interface - 100 % corresponds to	100
Scaling interface - 0 % corresponds to	0
Current output, output variable First HART variable (PV)	Lin. percent - Level
Current output - Output characteristics	0 ... 100 % correspond to 4 ... 20 mA
Current output - Reaction in case of fault	≤ 3.6 mA
Current output - Min.	3.8 mA
Current output - Max.	20.5 mA
Current output 2 - Output variable Second HART variable (SV)	Distance - Level
Current output 2 - Output characteristics	0 ... 100 % correspond to 4 ... 20 mA
Current output 2 - Reaction in case of fault	≤ 3.6 mA
Current output 2 - Min.	3.8 mA
Current output 2 - Max.	20.5 mA
Third HART variable (TV)	Measurement reliability, level
Fourth HART variable (QV)	Electronics temperature

Menu - Display

Menu item	Default value
Language	Selected language
Displayed value 1	Filling height Level
Displayed value 2	Electronics temperature
Backlight	Switched on

Menu - Diagnosis

Menu item	Default value
Status signals - Function control	Switched on
Status signals - Out of specification	Switched off
Status signals - Maintenance	Switched on
Device memory - Echo curve memory	Stopped
Device memory - Measured value memory	Started
Device memory - Measured value memory - Measured values	Distance level, percentage value level, reliability level, electronics temperature
Device memory - Measured value memory - Recording in time interval	3 min.
Device memory - Measured value memory - Recording with measured value difference	15 %
Device memory - Measured value memory - Start with measured value	Not active
Device memory - Measured value memory - Stop with measured value	Not active
Device memory - Measured value memory - Stop recording when memory is full	Not active

Menu - Additional adjustments

Menu item	Default value
PIN	0000
Date	Actual date
Time	Actual time
Time - Format	24 hours
Probe type	Device-specific
HART mode	Analogue current output

Copy instrument settings The instrument settings are copied with this function. The following functions are available:

- **Read from sensor:** Read data from sensor and store into the display and adjustment module
- **Write into sensor:** Store data from the display and adjustment module back into the sensor

The following data or settings for adjustment of the display and adjustment module are saved:

- All data of the menu "*Setup*" and "*Display*"
- In the menu "*Additional adjustments*" the items "*Reset*, *Date/Time*"
- Special parameters

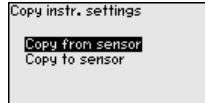
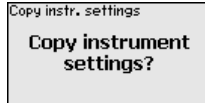

The copied data are permanently saved in an EEPROM memory in the display and adjustment module and remain there even in case of power failure. From there, they can be written into one or more sensors or kept as backup for a possible electronics exchange.



Note:

Before the data are stored in the sensor, a check is carried out to determine if the data fit the sensor. If the data do not fit, a fault signal is triggered or the function is blocked. When data are being written into the sensor, the display shows which instrument type the data originate from and which TAG-no. this sensor had.



Tip:

We recommend to save the instrument adjustments. In case of an electronics exchange the saved parameter adjustment data relieve this process.

Scaling level

Since scaling is very extensive, scaling of the level value was divided into two menu items.

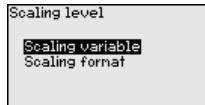

Scaling level - Scaling prime

In menu item "Scaling variable" you define the scaling variable and the scaling unit for the level value on the display, e.g. volume in l.

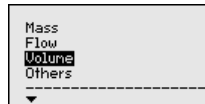
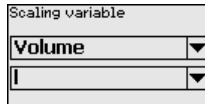

Scaling level - Scaling format

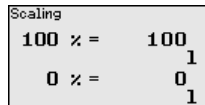
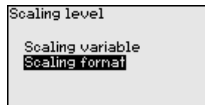

In menu item "Scaling format" you define the scaling format on the display and the scaling of the measured level value for 0 % and 100 %.

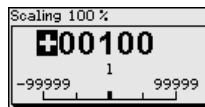

Scaling interface

Since scaling is very extensive, scaling of the interface value was divided into two menu items.

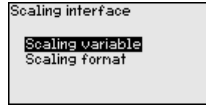

Scaling interface - Scaling size

In menu item "*Scaling variable*" you define the scaling variable and the scaling unit for the interface value on the display, e.g. volume in l.

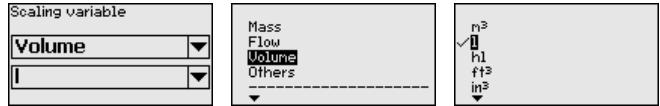

Scaling interface - Scaling format

In menu item "*Scaling format*" you define the scaling format on the display and the scaling of the measured interface value for 0 % and 100 %.

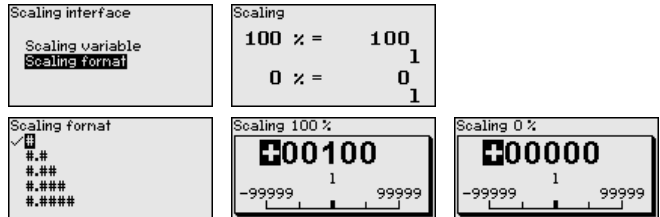

Current output

Since scaling is very extensive, scaling of the level value was divided into two menu items.

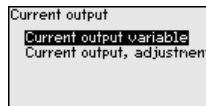

Current output - Current output size

In menu item "*Current output, variable*" you specify which measured variable the current output refers to.

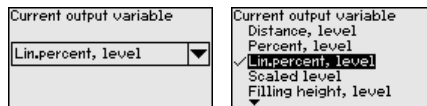

Current output - Current output adjustment

In menu item "*Current output, adjustment*" you can assign a respective measured value to the current output.

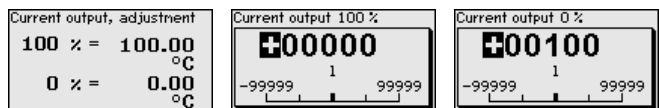

Probe type

In this menu item you can select the type and size of your probe from a list of all possible probes. This is necessary to adapt the electronics optimally to the probe.

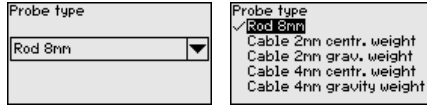

HART mode

The sensor is permanently set to the HART mode "Analogue current output". This parameter cannot be modified.

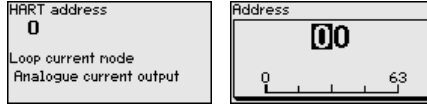

The default setting is "Analogue current output" and the address 00.

Special parameters

In this menu item you gain access to the protected area where you can enter special parameters. In exceptional cases, individual parameters can be modified in order to adapt the sensor to special requirements.

Change the settings of the special parameters only after having contacted our service staff.



7.3.5 Info

Device name

In this menu, you read out the instrument name and the instrument serial number.

Instrument version

In this menu item, the hardware and software version of the sensor is displayed.



Factory calibration date

In this menu item, the date of factory calibration of the sensor as well as the date of the last change of sensor parameters are displayed via the display and adjustment module or via the PC.



Sensor characteristics

In this menu item, the features of the sensor such as approval, process fitting, seal, measuring range, electronics, housing and others are displayed.

Sensor characteristics Display now?	Sensor characteristics Process fitting / Material Thread G1/2 FN6, DIN 3852-R / 316L	Sensor characteristics Cable entry / Conn ection M20x1.5 / Cable g1 and PH black
---	--	--

Example for displayed sensor features.

7.4 Saving the parameterisation data

On paper

We recommend writing down the adjustment data, e.g. in this operating instructions manual, and archiving them afterwards. They are thus available for multiple use or service purposes.

In the display and adjustment module

If the instrument is equipped with a display and adjustment module, the parameter adjustment data can be saved therein. The procedure is described in menu item "*Copy device settings*".

8 Diagnostics and servicing

8.1 Maintenance

If the device is used properly, no special maintenance is required in normal operation.

When used in safety-instrumented systems (SIS), the safety function must be carried out on the instrument in regular time intervals by means of a proof test.

Hence possible undetected, dangerous failure can be identified.

The operator's responsibility to select the kind of test. The time intervals depend on the used PFD_{AVG} .



During the function test, the safety function must be treated as unsafe. Keep in mind that the function test influences downstream connected devices.

If one of the tests proves negative, the entire measuring system must be switched out of service and the process held in a safe state by means of other measures.

You can find detailed information on the proof test in the Safety Manual (SIL).

8.2 Diagnosis memory

The instrument has several memories available for diagnostic purposes. The data remain there even in case of voltage interruption.

8.3 Status messages

The instrument features self-monitoring and diagnostics according to NE 107 and VDI/VDE 2650. In addition to the status messages in the following tables there are more detailed error messages available under the menu item "Diagnostics" via the respective adjustment module.

Status messages

The status messages are divided into the following categories:

- Failure
- Function check
- Out of specification
- Maintenance requirement

and explained by pictographs:

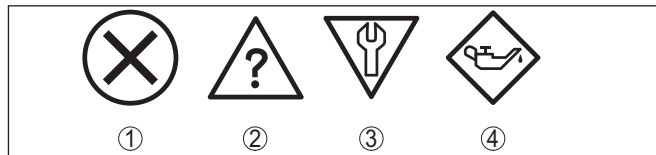

Fig. 15: Pictographs of the status messages

- 1 Failure - red
- 2 Out of specification - yellow
- 3 Function check - orange
- 4 Maintenance - blue

Failure: Due to a malfunction in the instrument, a fault message is output.

This status message is always active. It cannot be deactivated by the user.

Function check: The instrument is being worked on, the measured value is temporarily invalid (for example during simulation).

This status message is inactive by default.

Out of specification: The measured value is unreliable because an instrument specification was exceeded (e.g. electronics temperature).

This status message is inactive by default.

Maintenance: Due to external influences, the instrument function is limited. The measurement is affected, but the measured value is still valid. Plan in maintenance for the instrument because a failure is expected in the near future (e.g. due to buildup).

This status message is inactive by default.

Failure

Code Text message	Cause	Rectification	DevSpec State in CMD 48
F013 no measured value available	Sensor does not detect an echo during operation Process component or probe contaminated or defective	Check for correct mounting and/or parameter settings Clean or exchange process component or probe	Bit 0 of Byte 0 ... 5
F017 Adjustment span too small	Adjustment not within specification	Change adjustment according to the limit values (difference between min. and max. ≥ 10 mm)	Bit 1 of Byte 0 ... 5
F025 Error in the linearization table	Index markers are not continuously rising, for example illogical value pairs	Check values of the linearization table Delete/create a new linearization table	Bit 2 of Byte 0 ... 5
F036 No operable software	Failed or interrupted software update	Repeat software update Check electronics version Exchanging the electronics Send instrument for repair	Bit 3 of Byte 0 ... 5
F040 Error in the electronics	Hardware defect	Exchanging the electronics Send instrument for repair	Bit 4 of Byte 0 ... 5
F041 Probe loss	Cable probe broken or rod probe defective	Check probe and exchange, if necessary	Bit 13 of Byte 0 ... 5
F080 General software error	General software error	Disconnect operating voltage briefly	Bit 5 of Byte 0 ... 5
F105 Measured value is determined	The instrument is still in the start phase, the measured value could not yet be determined	Wait for the end of the switch-on phase Duration depending on the version and parameter adjustment max. 5 min.	Bit 6 of Byte 0 ... 5

Code Text message	Cause	Rectification	DevSpec State in CMD 48
F113 Communication error	EMC interference Transmission error during external communication with 4-wire power supply unit	Remove EMC influences Exchange 4-wire power supply unit or electronics	Bit 12 of Byte 0 ... 5
F125 Impermissible electronics temperature	Temperature of the electronics in the non-specified range	Check ambient temperature Insulate electronics Use instrument with higher temperature range	Bit 7 of Byte 0 ... 5
F260 Error in the calibration	Error in the calibration carried out in the factory Error in the EEPROM	Exchanging the electronics Send instrument for repair	Bit 8 of Byte 0 ... 5
F261 Error in the instrument settings	Error during setup Error when carrying out a reset False signal suppression faulty	Carry out a reset Repeat setup	Bit 9 of Byte 0 ... 5
F264 Installation/Set-up error	Error during setup	Check for correct mounting and/or parameter settings Check probe length	Bit 10 of Byte 0 ... 5
F265 Measurement function disturbed	Sensor no longer carries out a measurement	Carry out a reset Disconnect operating voltage briefly	Bit 11 of Byte 0 ... 5
F266 Impermissible operating voltage	Operating voltage below specified range	Check electrical connection If necessary, increase operating voltage	Bit 14 of Byte 0 ... 5
F267 No executable sensor software	Sensor cannot start	Exchanging the electronics Send instrument for repair	No communication possible

Tab. 6: Error codes and text messages, information on causes as well as corrective measures (some specifications are only valid for four-wire instruments)

Function check

Code Text message	Cause	Rectification	DevSpec State in CMD 48
C700 Simulation active	A simulation is active	Finish simulation Wait for the automatic end after 60 mins.	"Simulation Active" in "Standardized Status 0"
C701 Parameter verification	Parameter verification was interrupted	Finish parameter verification	Bit 12 of Byte 14 ... 24

Tab. 7: Error codes and text messages, information on causes as well as corrective measures

Out of specification

Code Text message	Cause	Rectification	DevSpec State in CMD 48
S601 Overfilling	Level echo in the close range not available	Reduce level 100 % adjustment: Increase value Check mounting socket Remove possible interfering signals in the close range Use coaxial probe	Bit 9 of Byte 14 ... 24

Tab. 8: Error codes and text messages, information on causes as well as corrective measures

Maintenance

Code Text message	Cause	Rectification	DevSpec State in CMD 48
M500 Error in the delivery status	The data could not be restored during the reset to delivery status	Repeat reset Load XML file with sensor data into the sensor	Bit 0 of Byte 14 ... 24
M501 Error in the non-active linearisation table	Index markers are not continuously rising, for example illogical value pairs	Check linearisation table Delete table/Create new	Bit 1 of Byte 14 ... 24
M504 Error at a device interface	Hardware defect	Exchanging the electronics Send instrument for repair	Bit 4 of Byte 14 ... 24
M506 Installation/Set-up error	Error during setup	Check and correct mounting and/or parameter adjustment Check probe length	Bit 6 of Byte 14 ... 24
M507 Error in the instrument settings	Error during setup Error when carrying out a reset False signal suppression faulty	Carry out reset and repeat setup	Bit 7 of Byte 14 ... 24

Tab. 9: Error codes and text messages, information on causes as well as corrective measures

8.4 Rectify faults

Reaction when malfunction occurs

The operator of the system is responsible for taking suitable measures to rectify faults.

Fault rectification

The first measures are:

- Evaluation of fault messages
- Checking the output signal
- Treatment of measurement errors

4 ... 20 mA signal

Connect a multimeter in the suitable measuring range according to the wiring plan. The following table describes possible errors in the current signal and helps to eliminate them:

Error	Cause	Rectification
4 ... 20 mA signal not stable	Fluctuating measured value	Set damping
4 ... 20 mA signal missing	Electrical connection faulty	Check connection, correct, if necessary
	Voltage supply missing	Check cables for breaks; repair if necessary
	Operating voltage too low, load resistance too high	Check, adapt if necessary
Current signal greater than 22 mA, less than 3.6 mA	Sensor electronics defective	Replace device or send in for repair depending on device version

Treatment of measurement errors

The below tables show typical examples for application-relevant measurement errors. There are two measurement errors:

- Constant level
- Filling
- Emptying

The images in column "Error pattern" show the real level as a broken line and the level displayed by the sensor as a continuous line.

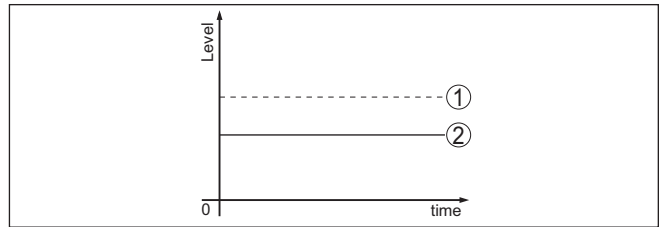

Fig. 16: The broken line 1 shows the real level, the continuous line 2 shows the level displayed by the sensor



Note:

If the output level is constant, the cause could also be the fault setting of the current output to "Hold value".

If the level is too low, the reason could be a line resistance that is too high

Measurement error with constant level

Fault description	Cause	Rectification
Measured value shows a too low or too high level 	Min./max. adjustment not correct	Adapt min./max. adjustment
	Incorrect linearisation curve	Adapt linearisation curve
	Running time error (small measurement error close to 100 %/serious error close to 0 %)	Repeat setup

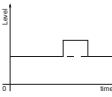
Fault description	Cause	Rectification
Measured value jumps towards 100 % 	Due to the process, the amplitude of the product echo decreases A false signal suppression was not carried out	Carry out a false signal suppression
	Amplitude or position of a false signal has changed (e.g. buildup); false signal suppression no longer matches	Determine the reason for the changed false signals, carry out false signal suppression, e.g. with buildup

Measurement error during filling

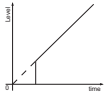
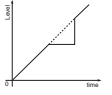
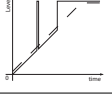
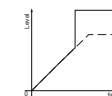
Fault description	Cause	Rectification
Measured value remains in the area of the bottom during filling 	Echo from the probe end larger than the product echo, for example, with products with $\epsilon_r < 2.5$ oil-based, solvents, etc.	Check parameter "Medium" and "Vessel height", adapt if necessary
Measured value remains momentarily unchanged during filling and then jumps to the correct level 	Turbulence on the product surface, quick filling	Check parameters, change if necessary, e.g. in dosing vessel, reactor
Measured value jumps sporadically to 100 % during filling 	Changing condensation or contamination on the probe	Carry out a false signal suppression
Measured value jumps to ≥ 100 % or 0 m distance 	Level echo is no longer detected in the close range due to false signals in the close range. The sensor goes into overfill protection mode. The max. level (0 m distance) as well as the status message "Overfill protection" are output.	Eliminate false signals in the close range Check installation conditions If possible, switch off the function "Overfill protection"

Measurement error during emptying

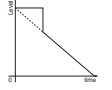
Fault description	Cause	Rectification
Measured value remains unchanged in the close range during emptying 	False signal larger than the level echo Level echo too small	Eliminate false signals in the close range Remove contamination on the probe. After having removed the source of the false signals, the false signal suppression must be deleted. Carry out a new false signal suppression

Fault description	Cause	Rectification
<p>Measured value remains reproducible in one position during emptying</p> 	<p>Stored false signals in this position are larger than the level echo</p>	<p>Delete false signal suppression Carry out a new false signal suppression</p>

Reaction after fault rectification

Depending on the reason for the fault and the measures taken, the steps described in chapter "Setup" must be carried out again or must be checked for plausibility and completeness.

8.5 Exchanging the electronics module

If the electronics module is defective, it can be replaced by the user.



In Ex applications, only instruments and electronics modules with appropriate Ex approval may be used.



With SIL qualified instrument, only a respective electronics module with SIL qualification must be used.

The electronics modules are adapted to the respective sensor. Hence the new electronics module must be loaded with the default settings of the sensor. These are the possibilities:

- In the factory
- Or on site by the user

In the factory

Order the replacement electronics module from the agency serving you.

When ordering the replacement electronics module, please state the serial number of the sensor.

The serial numbers are stated on the type label of the instrument, inside the housing as well as on the delivery note.

The replacement electronics module is provided with the serial number of the affected sensor. Before mounting, check if the serial number on the replacement electronics module and the serial number of the sensor correspond.

Then all application-specific settings must be entered again. Carry out a fresh setup after exchanging the electronics or load the stored data of the setup.

Or on site by the user



First you have to transfer the device-specific sensor data to the new electronics module.

You can download these individual, device-specific data of your sensor from our homepage.

Under "Instrument search (serial number)" you can download the specific sensor data as XML file with the sensor serial number directly to the sensor.

After the transfer of the sensor data, you have to verify the correct transmission by means of a check sum. Only then, the instrument will be ready for operation, again.

You can find the detailed process of the electronics exchange in the supplementary instructions "*Electronics module*".

Then all application-specific settings must be entered again. Carry out a fresh setup after exchanging the electronics or load the stored data of the setup.

If you saved the parameter settings during the first setup of the sensor, you can transfer them to the replacement electronics module. Also in this case a verification of the instrument is necessary.

8.6 How to proceed if a repair is necessary

If a repair should be necessary, please contact your contact person.

9 Dismount

9.1 Dismounting steps

**Warning:**

Before dismantling, be aware of dangerous process conditions such as e.g. pressure in the vessel or pipeline, high temperatures, corrosive or toxic media etc.

Take note of chapters "*Mounting*" and "*Connecting to voltage supply*" and carry out the listed steps in reverse order.

9.2 Disposal

The instrument consists of materials which can be recycled by specialised recycling companies. We use recyclable materials and have designed the electronics to be easily separable.

WEEE directive

The instrument does not fall in the scope of the EU WEEE directive. Article 2 of this Directive exempts electrical and electronic equipment from this requirement if it is part of another instrument that does not fall in the scope of the Directive. These include stationary industrial plants.

Pass the instrument directly on to a specialised recycling company and do not use the municipal collecting points.

If you have no way to dispose of the old instrument properly, please contact us concerning return and disposal.

10 Supplement

10.1 Technical data

General data

316L corresponds to 1.4404 or 1.4435

Materials, wetted parts

- Process fitting 316L and PEEK
- Process seal on the instrument side (rod leadthrough) FKM (SHS FPM 70C3 GLT), FFKM (Kalrez 6375), EPDM (A+P 70.10-02), silicone FEP coated (A+P FEP-O-SEAL)
- Process fitting (for volatile substances such as e.g. Ammonia) 316L
- Process seal, process side (for volatile substances such as e.g. Ammonia) Borosilicate glass GPC 540 with 316L and Alloy C22 (2.4602)¹⁾
- Process seal On site (instruments with thread: Klingsil C-4400 is enclosed)
- Inner conductor (up to the separation rod) 316L
- Spacers - Tube: ø 21.3 mm (0.839 in) PEEK
- Spacers - Tube: ø 42.2 mm (1.661 in) PFA
- Tube: ø 21.3 mm (0.839 in) 316L, 304L
- Tube: ø 42.2 mm (1.661 in) 316L, 304L

Materials, non-wetted parts

- Aluminium die-cast housing Aluminium die-casting AlSi10Mg, powder-coated (Basis: Polyester)
- Stainless steel housing (electropolished) 316L
- Temperature adapter 316L
- Second Line of Defense (optional) Borosilicate glass GPC 540 with 316L
- Seal between housing and housing lid Silicone SI 850 R
- Inspection window in housing cover (optional) Glass
- Ground terminal 316L
- Cable gland PA, stainless steel, brass
- Sealing, cable gland NBR
- Blind plug, cable gland PA

Second Line of Defense (optional)

- Supporting material 316L
- The Second Line of Defense (SLOD) is a second level of the process separation in the form of a gas-tight feedthrough in the lower part of the housing, preventing product from penetrating into the housing.

¹⁾ Not suitable for hot steam applications.

10 Supplement

- Glass potting	Borosilicate glass GPC 540
- Contacts	Alloy C22 (2.4602)
- Helium leak rate	< 10 ⁻⁶ mbar l/s
- Pressure resistance	See process pressure of the sensor
Conductive connection	Between ground terminal, process fitting and probe
Process fittings - tube: ø 21.3 mm (0.839 in)	
- Pipe thread, cylindrical (ISO 228 T1)	G¾, G1, G1½ (DIN 3852-A)
- Pipe thread, conical (ASME B1.20.1)	¾ NPT, 1 NPT, 1½ NPT
- Flanges	DIN from DN 25, ASME from 1"
Process fittings - tube: ø 42.2 mm (1.661 in)	
- Pipe thread, cylindrical (ISO 228 T1)	G1½ (DIN 3852-A)
- Pipe thread, conical (ASME B1.20.1)	1½ NPT
- Flanges	DIN from DN 50, ASME from 2"
Weight	
- Instrument weight (depending on process fitting)	approx. 0.8 ... 8 kg (0.176 ... 17.64 lbs)
- Tube: ø 21.3 mm (0.839 in)	approx. 1110 g/m (11.9 oz/ft)
- Tube: ø 42.2 mm (1.661 in)	approx. 3100 g/m (33.3 oz/ft)
Probe length L (from seal surface)	
- Tube: ø 21.3 mm (0.839 in)	up to 6 m (19.69 ft)
- Tube: ø 42.2 mm (1.661 in)	up to 6 m (19.69 ft)
- Trimming accuracy (tube)	±1 mm
Lateral load	
- Tube: ø 21.3 mm (0.839 in)	60 Nm (44 lbf ft)
- Tube: ø 42.2 mm (1.661 in)	300 Nm (221 lbf ft)
Torque for NPT cable glands and Conduit tubes	
- Aluminium/Stainless steel housing	max. 50 Nm (36.88 lbf ft)

Input variable

Measured variable	Level of liquids
Min. dielectric constant of the medium	$\epsilon_r \geq 1.4$

Output variable

Output signal	4 ... 20 mA/HART
Range of the output signal	3.8 ... 20.5 mA/HART (default setting)
Fulfilled HART specification	7
Signal resolution	0.3 µA
Fault signal, current output (adjustable)	$\geq 21.0 \text{ mA}, \leq 3.6 \text{ mA}$ In order to detect the rarely occurring hardware failures in the device, we recommend monitoring both interference values
Max. output current	21.5 mA

Starting current

- for 5 ms after switching on ≤ 10 mA
- for run-up time ≤ 3.6 mA

Load see load diagram under Power supply

Damping (63 % of the input variable), adjustable 0 ... 999 s

HART output values according to HART 7 (default setting)²⁾

- First HART value (PV) Linearised percentage value, level
- Second HART value (SV) Distance to the level
- Third HART value (TV) Measurement reliability, level
- Fourth HART value (QV) Electronics temperature

Indication value - Display and adjustment module³⁾

- Displayed value 1 Filling height Level
- Displayed value 2 Electronics temperature

Resolution, digital < 1 mm (0.039 in)

Measurement accuracy (according to DIN EN 60770-1)
Process reference conditions according to DIN EN 61298-1

- Temperature +18 ... +30 °C (+64 ... +86 °F)
- Relative humidity 45 ... 75 %
- Air pressure +860 ... +1060 mbar/+86 ... +106 kPa
(+12.5 ... +15.4 psig)

Mounting, reference conditions

- Min. distance to internal installations > 500 mm (19.69 in)
- Vessel metallic, ø 1 m (3.281 ft), centric mounting, process fitting flush with the vessel ceiling
- Medium Water/Oil (dielectric constant ~2.0)⁴⁾
- Mounting Probe end does not touch the vessel bottom

Sensor parameter adjustment No gating out of false signals carried out

²⁾ The output values can be assigned individually.

³⁾ The indication values can be assigned individually.

⁴⁾ With interface measurement = 2.0.

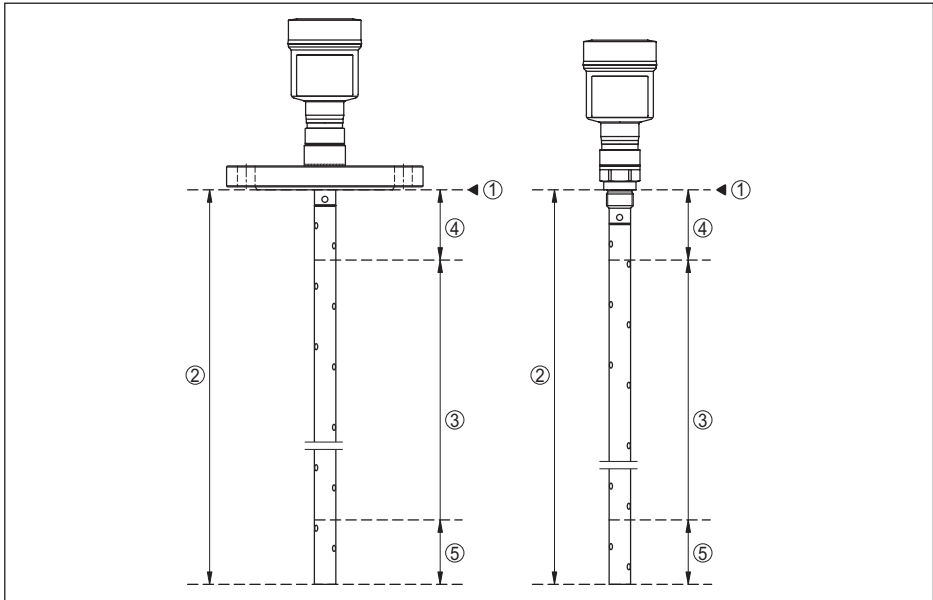

Fig. 17: Measuring ranges - NivoGuide 8100

- 1 Reference plane
- 2 Probe length L
- 3 Measuring range (default setting refers to the measuring range in water)
- 4 Upper dead zone (see following diagrams - grey section)
- 5 Lower dead zone (see following diagrams - grey section)

Typical deviation - Interface measurement $\pm 5 \text{ mm (0.197 in)}$

Typical deviation - Total level interface measurement $\pm 5 \text{ mm (0.197 in)}$

Typical deviation - Level measurement⁵⁾⁶⁾ See following diagrams

⁵⁾ Depending on the mounting conditions, deviations can occur which can be rectified by adapting the adjustment or changing the measured value offset in the DTM service mode

⁶⁾ The dead zones can be optimized via a false signal suppression.

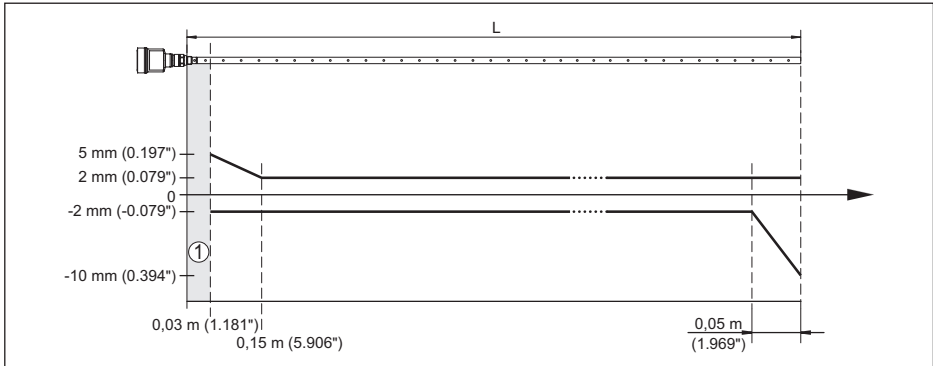

Fig. 18: Deviation NivoGuide 8100 in coaxial version in water

- 1 Dead zone (no measurement possible in this area)
 L Probe length

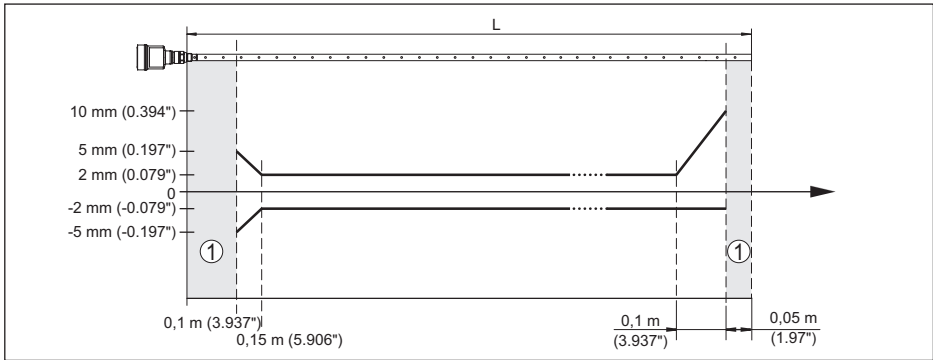

Fig. 19: Deviation NivoGuide 8100 in coaxial version in oil

- 1 Dead zone (no measurement possible in this area)
 L Probe length

Non-repeatability $\leq \pm 1$ mm

Specifications of the safety tolerance See "Safety Manual" (SIL)

Variables influencing measurement accuracy

Specifications for the digital measured value

Temperature drift - Digital output ± 3 mm/10 K relating to the max. measuring range or max. 10 mm (0.394 in)

Additional deviation through electromagnetic interference acc. to EN 61326 $< \pm 10$ mm ($< \pm 0.394$ in)

Specifications apply also to the current output⁷⁾

Temperature drift - Current output ± 0.03 %/10 K relating to the 16 mA span or max. ± 0.3 %

⁷⁾ Also for the additional current output (optional).

Deviation in the current output due to digital/analogue conversion

- Non-Ex and Ex-ia version <math>< \pm 15 \mu\text{A}</math>
- Ex-d-ia version <math>< \pm 40 \mu\text{A}</math>

Additional deviation through electromagnetic interference acc. to EN 61326 <math>< \pm 150 \mu\text{A}</math>

Influence of the superimposed gas and pressure on measurement accuracy

The propagation speed of the radar impulses in gas or vapour above the medium is reduced by high pressure. This effect depends on the superimposed gas or vapours.

The following table shows the resulting deviation for some typical gases and vapours. The specified values refer to the distance. Positive values mean that the measured distance is too large, negative values that the measured distance is too small.

Gas phase	Temperature	Pressure		
		1 bar (14.5 psig)	10 bar (145 psig)	50 bar (725 psig)
Air	20 °C (68 °F)	0 %	0.22 %	1.2 %
	200 °C (392 °F)	-0.01 %	0.13 %	0.74 %
	400 °C (752 °F)	-0.02 %	0.08 %	0.52 %
Hydrogen	20 °C (68 °F)	-0.01 %	0.1 %	0.61 %
	200 °C (392 °F)	-0.02 %	0.05 %	0.37 %
	400 °C (752 °F)	-0.02 %	0.03 %	0.25 %
Steam (saturated steam)	100 °C (212 °F)	0.26 %	-	-
	180 °C (356 °F)	0.17 %	2.1 %	-
	264 °C (507 °F)	0.12 %	1.44 %	9.2 %
	366 °C (691 °F)	0.07 %	1.01 %	5.7 %

Characteristics and performance data

Measuring cycle time	<math>< 500 \text{ ms}</math>
Step response time ⁸⁾	$\leq 3 \text{ s}$
Max. filling/emptying speed	1 m/min
	Products with high dielectric constant (>10) up to 5 m/min.

Ambient conditions

Ambient, storage and transport temperature -40 ... +80 °C (-40 ... +176 °F)

Process conditions

For the process conditions, please also note the specifications on the type label. The lowest value always applies.

The measurement error through the process conditions in the specified pressure and temperature range is <math>< 1 \text{ \%}</math>.

⁸⁾ Time span after a sudden measuring distance change by max. 0.5 m in liquid applications, max 2 m with bulk solids applications, until the output signal has taken for the first time 90 % of the final value (IEC 61298-2).

Process pressure

- Standard version -1 ... +40 bar/-100 ... +4000 kPa (-14.5 ... +580 psig), depending on the process fitting
- with borosilicate glass leadthrough -1 ... +100 bar/-100 ... +10000 kPa (-14.5 ... +1450 psig), depending on the process fitting

Vessel pressure relating to the flange nominal pressure stage

 see supplementary instructions manual "*Flanges according to DIN-EN-ASME-JIS*"

Process temperature (thread or flange temperature)

- FKM (SHS FPM 70C3 GLT) -40 ... +150 °C (-40 ... +302 °F)
- EPDM (A+P 70.10-02) -40 ... +150 °C (-40 ... +302 °F)
- FFKM (Kalrez 6375) -20 ... +150 °C (-4 ... +302 °F)
- FFKM (Kalrez 6375) -20 ... +200 °C (-4 ... +392 °F)
- with borosilicate glass leadthrough -60 ... +150 °C (-76 ... +302 °F)

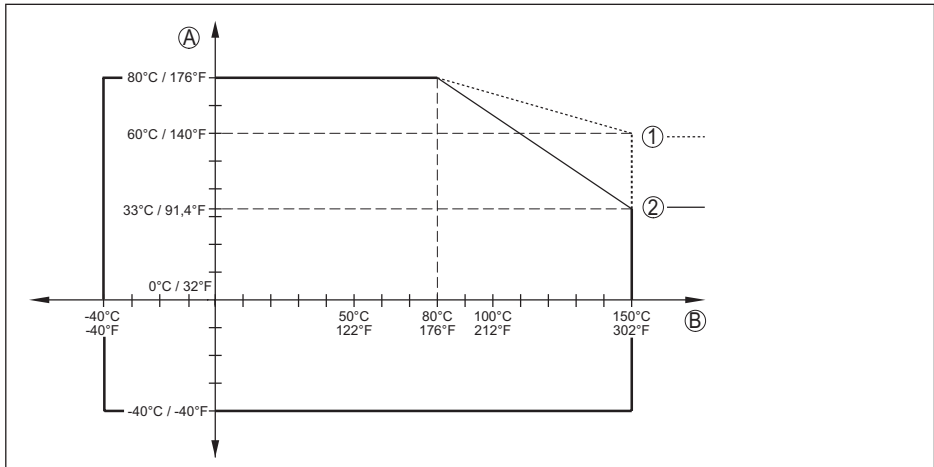

Fig. 20: Ambient temperature - process temperature, standard version

- A Ambient temperature
- B Process temperature (depending on the seal material)
- 1 Aluminium housing
- 2 Stainless steel housing (precision casting)
- 3 Stainless steel housing (electropolished)

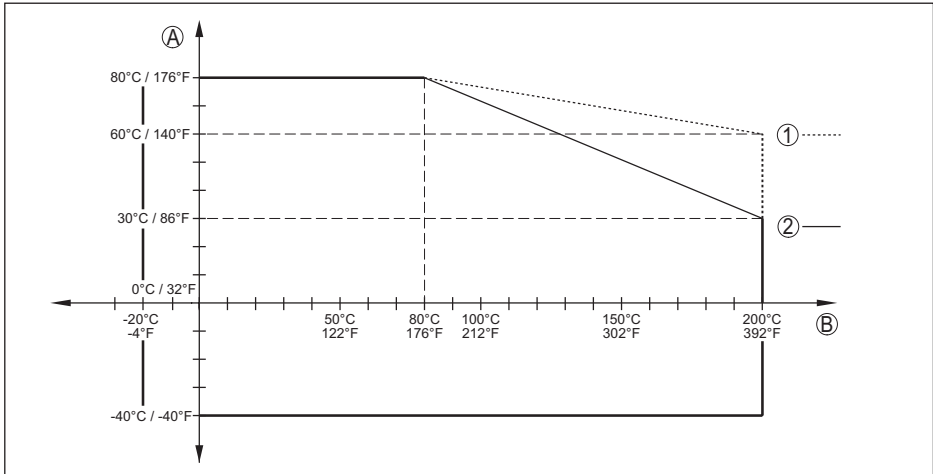

Fig. 21: Ambient temperature - process temperature, version with temperature adapter

- A Ambient temperature
- B Process temperature (depending on the seal material)
- 1 Aluminium housing
- 2 Stainless steel housing (precision casting)
- 3 Stainless steel housing (electropolished)

Viscosity - dynamic	0.1 ... 500 mPa s (requirement: with density 1)
Vibration resistance	
– Coax probe	1 g with 5 ... 200 Hz according EN 60068-2-6 (vibration at resonance) with tube length 50 cm (19.69 in)
Shock resistance	
– Coax probe	25 g, 6 ms according to EN 60068-2-27 (mechanical shock) with tube length 50 cm (19.69 in)

Electromechanical data - version IP 66/IP 67 and IP 66/IP 68; (0.2 bar)

Cable entry	
– M20 x 1.5	1 x cable gland M20 x 1.5 (cable: ø 6 ... 12 mm), 1 x blind plug M20 x 1.5
– ½ NPT	1 x blind plug NPT, 1 x closing cap (red) ½ NPT
Wire cross-section (spring-loaded terminals)	
– Massive wire, stranded wire	0.2 ... 2.5 mm ² (AWG 24 ... 14)
– Stranded wire with end sleeve	0.2 ... 1.5 mm ² (AWG 24 ... 16)

Electromechanical data - version IP 66/IP 68 (1 bar)

Connection cable	
– Configuration	four wires, one suspension cable, braiding, metal foil, cover
– Wire cross-section	0.5 mm ² (AWG 20)
– Wire resistance	< 0.036 Ω/m

- Tensile strength	< 1200 N (270 lbf)
- Standard length	5 m (16.4 ft)
- Max. length	180 m (590.6 ft)
- Min. bending radius	25 mm (0.984 in) with 25 °C (77 °F)
- Diameter approx.	8 mm (0.315 in)
- Colour - Non-Ex version	Black
- Colour - Ex-version	Blue

Integrated clock

Date format	Day.Month.Year
Time format	12 h/24 h
Time zone, factory setting	CET
Max. rate deviation	10.5 min/year

Additional output parameter - Electronics temperature

Range	-40 ... +85 °C (-40 ... +185 °F)
Resolution	< 0.1 K
Deviation	±3 K
Output of the temperature values	
- Indication	Via the display and adjustment module
- Output	Via the respective output signal

Voltage supply

Operating voltage U_B	
- Non-Ex instrument, Ex-d instrument	9.6 ... 35 V DC
- Ex-ia instrument	9.6 ... 30 V DC
- Ex-d-ia instrument	15 ... 35 V DC
- Ex-d-ia instrument with ship approval	15 ... 35 V DC
Operating voltage U_B with lighting switched on	
- Non-Ex instrument, Ex-d instrument	16 ... 35 V DC
- Ex-ia instrument	16 ... 30 V DC
- Ex-d-ia instrument	No lighting (integrated ia barrier)
Reverse voltage protection	Integrated
Permissible residual ripple - Non-Ex, Ex-ia instrument	
- for $9.6 V < U_B < 14 V$	$\leq 0.7 V_{\text{eff}}$ (16 ... 400 Hz)
- for $18 V < U_B < 36 V$	$\leq 1 V_{\text{eff}}$ (16 ... 400 Hz)
Permissible residual ripple - Ex-d-ia instrument	
- for $18 V < U_B < 36 V$	$\leq 1 V_{\text{eff}}$ (16 ... 400 Hz)
Load resistor	
- Calculation	$(U_B - U_{\text{min}})/0.022 A$
- Example - Non-Ex instrument with $U_B = 24 V$ DC	$(24 V - 9.6 V)/0.022 A = 655 \Omega$

Potential connections and electrical separating measures in the instrument

Electronics	Not non-floating
Reference voltage ⁹⁾	500 V AC
Conductive connection	Between ground terminal and metallic process fitting

Electrical protective measures

Housing material	Version	Protection acc. to IEC 60529	Protection acc. to NEMA
Aluminium	Single chamber	IP 66/IP 68 (0.2 bar)	Type 6P
	Double chamber	IP 66/IP 68 (0.2 bar)	Type 6P
Stainless steel (electro-polished)	Single chamber	IP 66/IP 68 (0.2 bar)	Type 6P

Connection of the feeding power supply unit Networks of overvoltage category III

Altitude above sea level

- by default up to 2000 m (6562 ft)
- with connected overvoltage protection up to 5000 m (16404 ft)

Pollution degree (with fulfilled housing protection) 4

Protection rating (IEC 61010-1) III

10.2 Dimensions

The following dimensional drawings are only an extract of the possible versions.

Aluminium housing

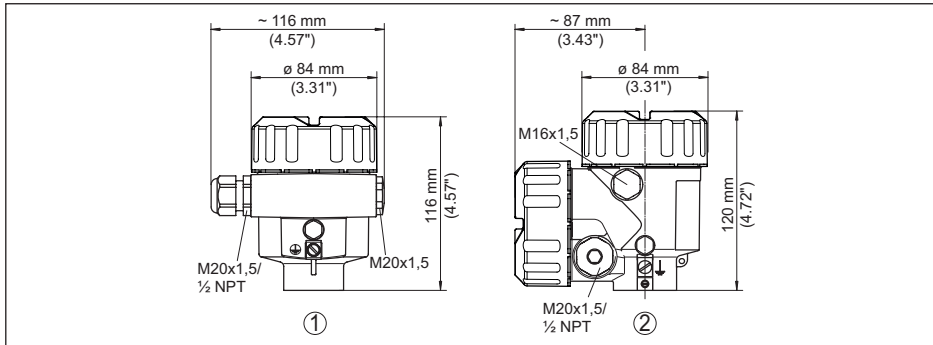

Fig. 22: Housing versions with protection rating IP 66/IP 68 (0.2 bar), (with integrated display and adjustment module the housing is 9 mm/0.35 in higher)

- 1 Aluminium - single chamber
- 2 Aluminium - double chamber

⁹⁾ Galvanic separation between electronics and metal housing parts

Stainless steel housing

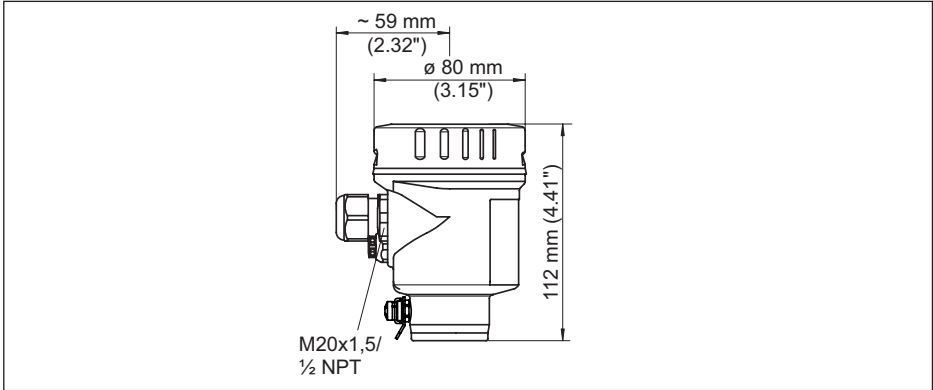

Fig. 23: Housing versions with protection rating IP 66/IP 68 (0.2 bar), (with integrated display and adjustment module the housing is 9 mm/0.35 in higher)

- 1 Stainless steel single chamber (electropolished)
- 2 Stainless steel single chamber (precision casting)
- 3 Stainless steel double chamber housing (precision casting)

NivoGuide 8100, coax version

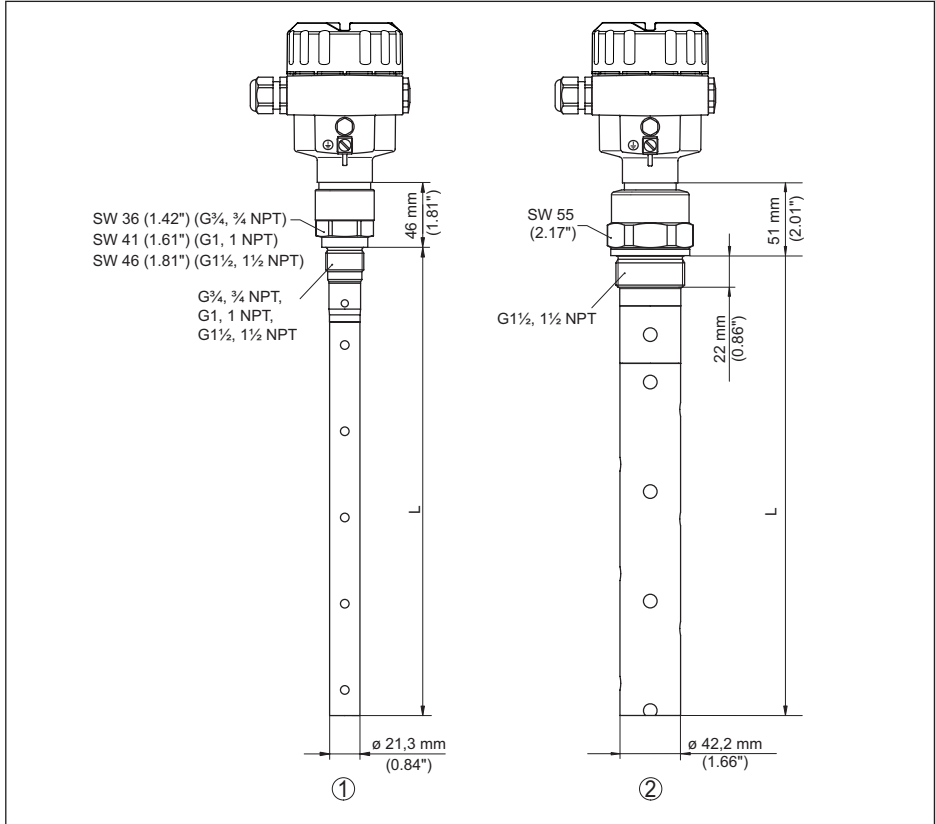

Fig. 24: NivoGuide 8100, threaded version

L Sensor length, see chapter "Technical data"

1 Coaxial version \varnothing 21.3 mm (0.839 in)

2 Coaxial version \varnothing 42.2 mm (1.661 in)

10.3 Trademark

All the brands as well as trade and company names used are property of their lawful proprietor/originator.

INDEX

A

Adjustment

- Max. adjustment 32
- Min. adjustment 32, 33

Adjustment system 28

Application 30, 31

Application area 9

B

Backlight 39

C

Check output signal 53

Copy sensor settings 45

Current output 47

Current output 2 38

Current output, adjustment 47

Current output, meas. variable 47

Current output, min./max. 35

Current output mode 34

Curve display

- Echo curve 41

D

Damping 33

Date of manufacture 48

Date/Time 42

Default values 43

Deviation 54

Display format 39

E

Echo curve of the setup 41

Electrical connection 17

Electronics and connection compartment 19

Electronics compartment - double chamber housing 19

F

Factory calibration date 48

False signal suppression 35

Fault

- Rectification 53

Fault rectification 53

Functional principle 9

Functional safety (SIL) 21

Function test 23, 37

G

Gas phase 31

Grounding 17

H

HART address 48

I

Inflowing medium 13

Installation position 13

K

Key function 27

L

Language 38

Linearisation 33

M

Main menu 29

Measured value indication 38

Measurement loop name 29

Measurement reliability 40

N

NAMUR NE 107 50

- Failure 51

- Function check 52

- Maintenance 53

- Out of specification 53

P

Peak value indicator 39, 40

PIN 22, 36

Probe length 30

Probe type 47

Proof test 42

R

Read out info 48

Repair 57

Reset 42

S

Scaling measured value 46, 47

Sensor characteristics 48

Sensor status 39

SIL 21

Simulation 41

Special parameters 48

T

Type label 8

Type of medium 30

U

Units 30

Unlock adjustment 36

V

Verify parameter 25

Printing date:

All statements concerning scope of delivery, application, practical use and operating conditions of the sensors and processing systems correspond to the information available at the time of printing.
Subject to change without prior notice

Technical support

Please contact your local sales partner (address at www.uwt.de). Otherwise please contact us:

UWT GmbH
Westendstraße 5
87488 Betzigau
Germany

Phone +49 831 57123-0
Fax +49 831 76879
info@uwt.de
www.uwt.de

61893-EN-190911